



9XTend-PKG-U

USB RF Modem

User Guide

Revision history—90000816

Revision	Date	Description
A	March 2007	Baseline release.
B	February 2016	Added support for XTend vB devices. Miscellaneous editorial changes.
C	May 2018	Added explanation of range estimates.

Product documentation

To find up-to-date documentation for all Digi products, visit www.digi.com/documentation.

To provide feedback on this documentation, send your comments to techcomm@digi.com.

Trademarks and copyright

Digi, Digi International, and the Digi logo are trademarks or registered trademarks in the United States and other countries worldwide. All other trademarks mentioned in this document are the property of their respective owners.

© 2018 Digi International. All rights reserved.

Disclaimers

Information in this document is subject to change without notice and does not represent a commitment on the part of Digi International. Digi provides this document “as is,” without warranty of any kind, expressed or implied, including, but not limited to, the implied warranties of fitness or merchantability for a particular purpose. Digi may make improvements and/or changes in this manual or in the product(s) and/or the program(s) described in this manual at any time.

All range figure estimates within this guide are based on free-air terrain with limited sources of interference. Actual range will vary based on transmitting power, orientation of transmitter and receiver, height of transmitting antenna, height of receiving antenna, weather conditions, interference sources in the area, and terrain between receiver and transmitter, including indoor and outdoor structures such as walls, trees, buildings, hills, and mountains.

Warranty

To view product warranties online, visit www.digi.com/howtobuy/terms.

Customer support

Digi offers multiple technical support plans and service packages to help our customers get the most out of their Digi product. For information on Technical Support plans and pricing, please contact us at 952.912.3456 or visit www.digi.com/support.

If you have a customer account, sign in to the Customer Support Web Portal at www.digi.com/support/eservice

Contents

About the RF Modems

Applicable hardware	6
Key features	6
Worldwide acceptance	7
Specifications	7
Performance specifications	8
Power requirements	8
Networking and security specifications	9
Physical specifications	10
User-selected TX Power Output specifications	10
External interface	11
Pin signals	12
Power options	12

Operation

USB background information	13
Serial communications	13
Transparent operation	13
API operation	14
Modes of operation	14
Idle mode	14
Transmit mode	15
Receive mode	16
Sleep mode	17
Command mode	19
AT Command mode	20
Binary Command mode	21

Configure the RF Modem

Use XCTU to configure the RF Modem	23
Load default firmware settings	23
Binary commands	24
Command reference table	25
Command descriptions	28
%V (Board Voltage) Command	28
AM (Auto-set MY) Command	28
AP (API Enable) command	29
AT (Guard Time After) command	29
BD (Interface Data Rate) command	29
BR (RF Data Rate) command	30
BT (Guard Time Before) command	31
CC (Command Sequence Character) command	32
CD (GPO2 Configuration) Command	32
CF (Number Base) Command	33
CN (Exit AT Command Mode) Command	33
CS (GPO1 Configuration) Command	33
CT (Command Mode Timeout) Command	34
DB (Received Signal Strength) Command	34

DT (Destination Address) Command	35
E0 (Echo Off) Command	35
E1 (Echo On) Command	35
ER (Receive Error Count) Command	35
FH (Force Wake-up Initializer) Command	36
FL (Software Flow Control) Command	36
FS (Forced Sync Time) Command	36
FT (Flow Control Threshold) Command	37
GD (Receive Good Count) Command	37
HP (Hopping Channel) Command	37
HT (Time before Wake-up Initializer) Command	38
HV (Hardware Version) Command	38
ID (Modem VID) Command	39
KY (AES Encryption Key) Command	39
LH (Wake-up Initializer Timer) Command	39
MD (RF Mode) Command	40
MK (Address Mask) Command	41
MT (Multi-transmit) Command	41
MY (Source Address) Command	42
NB (Parity) Command	42
PB (Polling Begin Address) Command	42
PD (Minimum Polling Delay) Command	43
PE (Polling End Address) Command	43
PK (Maximum RF Packet Size) Command	44
PL (TX Power Level) Command	44
PW (Pin Wake-up) Command	45
RB (Packetization Threshold) Command	45
RC (Ambient Power - Single Channel) Command	46
RE (Restore Defaults) Command	46
RM (Ambient Power - All Channels) Command	46
RN (Delay Slots) Command	47
RO (Packetization Timeout) Command	47
RP (RSSI PWM Timer) Command	48
RR (Retries) Command	49
RT (GPI1 Configuration) Command	49
SB (Stop Bits) Command	49
SH (Serial Number High) Command	50
SL (Serial Number Low) Command	50
SM (Sleep Mode) Command	50
ST (Time before Sleep) Command	51
TP (Board Temperature) Command	52
TR (Transmit Error Count) command	52
TT (Streaming Limit) command	52
TX (Transmit Only) command	53
VL (Firmware Version - Verbose)	53
VR (Firmware Version - Short) Command	53
WA (Active Warning Numbers) command	54
WN (Warning Data) command	54
WR (Write) command	55
WS (Sticky Warning Numbers) command	55
API operation	56
API frame specifications	56
API Types	57
RF Modem Status	57

RF communication modes

Network topologies	60
Point-to-point networks	60
Definition	60
Sample network profile (Broadcast communications)	60
Sample network profile (Acknowledged communications)	60
Point-to-multipoint networks	61
Definition	61
Sample network profile (Broadcast communications)	61
Basic RF modes	62
Acknowledged RF mode	62
Peer to peer networks	62
Definition	62
Sample network profile (Broadcast communications)	62
Sample network profile (Acknowledged communications)	62
Basic RF modes	62
Acknowledged RF mode	63
Addressing	63
Address recognition	63
Basic communications	63
Streaming mode (default)	64
Streaming mode connection sequence	64
Multi-transmit mode	64
Multi-transmit mode connection sequence	65
Repeater mode	65
Repeater mode theory of operation	66
Configure a repeater network	66
Repeater network: configure communications	67
Repeater network algorithm details	67
Repeat delay based on RSSI	67
Response packet delay	68
Bandwidth considerations	69
Polling mode (basic)	69
Polling mode theory of operation	70
Configure a Polling Base	70
Configure a Polling Remote	70
Acknowledged communications: Acknowledged mode	70
Acknowledged mode connection sequence	71
Polling mode (acknowledged)	72

Agency certifications

FCC (United States) Certification	73
FCC Part 15 Class B	73
IC (Industry Canada) Certification	74
RF Exposure	74
ACMA (Australia)	74
Power requirements	74
Legacy XTend Modem FCC-approved antennas	75
XTend vB Modem FCC-approved antennas (30 dBm Maximum RF power)	80

About the RF Modems

The 9XTend RF Modem affords OEMs and integrators an easy-to-use RF solution that sustains reliable delivery of data between remote devices.

Out-of-box, the modem is configured to immediately sustain long range wireless links between devices. Simply feed serial data into one modem, then the data will surface on the other end of the wireless link. The modem transfers a standard asynchronous serial data stream between devices, features 256-bit AES encryption and sustains up to 115.2 Kb/s data throughput.

Applicable hardware

This manual covers both the 9XTend-PKG-U USB RF Modem and the XTend vB USB RF Modem. Throughout the manual, you will see references to the *Legacy Modem* and the *XTend vB Modem*. Legacy modems have part numbers with the format **XT09-PK.-.** and contain radio model **XT09**. XTend vB modems have part numbers with the format **XTP9B-PK.-.** and contain radio model **XBP9X**.

Key features

Long Range Data Integrity

1 Watt Power Output

Range (@9,600 b/s throughput data rate):

- Indoor: **up to 1000'** (300 m)
- Outdoor RF line-of-sight: **up to 14 miles** (22 km) w/dipole antenna
- Outdoor RF line-of-sight: **up to 40 miles** (64 km) w/high-gain antenna

Range (@115,200 b/s throughput data rate):

- Indoor: **up to 500'** (150 m)
- Outdoor RF line-of-sight: **up to 7 miles** (11 km) w/dipole antenna
- Outdoor RF line-of-sight: **up to 20 miles** (32 km) w/high-gain antenna

Continuous RF data stream up to **115,200 b/s**

Receiver Sensitivity: **-110 dBm** (@ 9600 baud), **-100 dBm** (@ 115200 baud)

Advanced Networking and Security

- True Peer-to-Peer (no Master device required), Point-to-Point, Point-to-Multipoint and Multidrop

- Retries and Acknowledgments
- FHSS (Frequency Hopping Spread Spectrum)
- 10 hopping channels, each with over 65,000 unique network addresses available
- 256-bit AES Encryption (AES algorithm is FIPS-197 certified)

Low Power

- 7 - 28 V Supply Voltage
- Pin, Serial Port and Cyclic software sleep modes supported

Easy-to-Use

- No configuration necessary for out-of box RF communications
- External DIP Switch configuration
- Free XCTU Software (Testing and configuration software)
- RF Modems easily configured using standard AT and binary commands
- Transparent Operation (Wireless links replace serial wires)
- API Operation (Frame-based communications)
- Portable (small form-factor easily fits into a wide range of data systems)
- Software-selectable I/O interfacing rates
- Multiple data formats supported (parity, start and stop bits, etc.)
- XII™ Interference Immunity
- No Master/Slave setup dependencies

Worldwide acceptance

FCC Approved (USA) Refer to [Agency certifications](#) on page 73 for FCC Requirements. Systems that include XTend RF Modems inherit Digi's Certifications.

ISM (Industrial, Scientific and Medical) license-free 902-928 MHz frequency band

Manufactured under **ISO 9001:2000** registered standards

9XTend RF Modems are optimized for use in the **US, Canada, Australia and Israel**



Specifications

Out-of-box, the 9XTend RF Modem is configured to provide immediate long range wireless links between devices. The modem can be configured to support additional functionality through the use of standard AT and binary commands. Refer to [Command mode](#) on page 19 and [Configure the RF Modem](#) on page 23 for more information. The following table provides the specifications.

Performance specifications

Note Range figure estimates are based on free-air terrain with limited sources of interference. Actual range will vary based on transmitting power, orientation of transmitter and receiver, height of transmitting antenna, height of receiving antenna, weather conditions, interference sources in the area, and terrain between receiver and transmitter, including indoor and outdoor structures such as walls, trees, buildings, hills, and mountains.

This document describes how Digi RF products are designed to have good out-of-band interference rejection from other sources of RF emissions 1 MHz or more away from the frequency in which the Digi RF product is designed to operate. An out-of-band interfering radio is one that is intended to broadcast in one frequency but has RF energy that bleeds-over to affect a second radio operating on a different frequency. Final performance can still vary at any particular installation site, dependent on both the physical environment in which the radio is installed and the amount of in-band and out-of-band interference sources broadcasting in that same localized area.

Specification	@9600 b/s Throughput Data Rate	@115200 b/s Throughput Data Rate
Transmit Power Output (software selectable using PL command)	Legacy RF Modem: 1mW - 1 Watt	Legacy RF Modem: 1mW - 1 Watt
	XTend vB Modem: 100 mW - 1 Watt	XTend vB Modem: 100 mW - 1 Watt
Indoor/Urban Range	Up to 1000' (300 m)	Up to 500' (150 m)
Outdoor RF line-of-sight Range	Up to 14 miles (22 km) w/ dipole antenna	Up to 7 miles (11 km) w/ dipole antenna
	Up to 40 miles (64 km) w/ high-gain antenna	Up to 20 miles (32 km) w/ high-gain antenna
Interface Data Rate (software selectable using BD command)	1200 – 230400 b/s	1200 – 230400 b/s
Throughput Data Rate (software selectable using BR command)	9,600 b/s	115,200 b/s
RF Data Rate	10,000 b/s	125,000 b/s
Receiver Sensitivity	-110 dBm	-100 dBm

Power requirements

The following table provides the power requirements. When powered from USB (Bus power), current is measured on the 5V USB bus. When externally powered (Self power), current is measured with a 9V supply. External power must be in the range of 7 to 28V and corresponding currents can be estimated based on a constant-power curve. When external power is used, the USB draws a fixed current of approximately 25 mA.

	Legacy RF Modem		XTend vB Modem	
	Bus Power (mA)	Self Power (mA, V _{in} =9V)	Bus Power (mA)	Self Power (mA, V _{in} =9V)
Receive Current	120	65	65	30
Serial Port Sleep Current	42	15	35	10
Pin Sleep Current	31	8	31	8

Sleep mode	Cycle time	RF data rate	Legacy, bus power	Legacy, self power	XTend vB, bus power	XTend vB, self power
			Cyclic sleep current (mA, average)	Cyclic sleep current (mA, average)	Cyclic sleep current (mA, average)	Cyclic sleep current (mA, average)
SM=8	16 seconds	BR=0	33	9	32	8
		BR=1	31	8	31	8
SM=7	8 seconds	BR=0	34	10	32	9
		BR=1	31	8	31	8
SM=6	4 seconds	BR=0	37	12	33	9
		BR=1	32	8	31	8
SM=5	2 seconds	BR=0	42	15	34	10
		BR=1	32	9	31	8
SM=4	1 second	BR=0	51	20	37	12
		BR=1	33	10	32	9

Networking and security specifications

Specification	Value
Frequency	902-928 MHz
Spread Spectrum	FHSS (Frequency Hopping Spread Spectrum)
Modulation	FSK (Frequency Shift Keying)
Network Topologies Supported	Peer-to-Peer (“Master/Slave” relationship not required), Point-to-Point, Point-to-Multipoint and Multidrop
Channel Capacity	10 hop sequences share 50 frequencies
Encryption	256-bit AES Encryption – To implement, refer to the KY (AES Encryption Key) Command on page 39

Physical specifications

Specification	Value
RF Modem Board Size	2.750" x 5.500" x 1.125" (6.99cm x 13.97" x 2.86cm)
Weight	7.1 oz. (200g)
Data Interface Connector	USB, Type B
Power Connector	2.1 mm barrel
Operating Temperature	-40 to 85° C (industrial)
Antenna	
Connector	RPSMA (Reverse-polarity SMA)
Impedance	50 ohms unbalanced
Regulatory approvals	FCC Part 15B. See Agency certifications on page 73 for important information.

User-selected TX Power Output specifications

Transmit Power Output	1 mW	10 mW	100 mW	500 mW*	1 W*
Legacy Modem					
TX Current typical (Bus Power)	130 mA	170 mA	300 mA	Not supported	Not supported
TX Current typical (Self Power)	70 mA	95 mA	185 mA	360 mA	575 mA
XTend vB Modem					
TX Current typical (Bus Power)	N/A	N/A	300 mA	Not supported	Not supported
TX Current typical (Self Power)	N/A	N/A	155 mA	300 mA	430 mA
* If the supply voltage for a given power setting is lower than the minimum supply voltage requirement, the TX Power Output will decrease to the highest power level setting given the current supply voltage.					

External interface

1-01a. I/O & Power LEDs

Front View

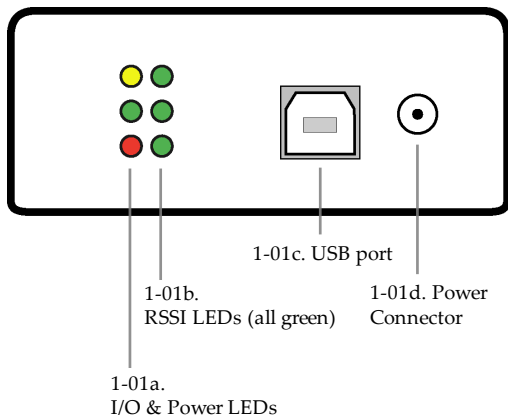

LEDs indicate modem activity as follows:

Yellow (top LED)= Serial Data Out (to host)

Green (middle) = Serial Data In (from host)

Red (bottom) = Power/TX Indicator (Red light is on when powered; it pulses on/off briefly during RF transmission.)



1-01b. RSSI LEDs

RSSI LEDs indicate the amount of fade margin present in an active wireless link. Fade margin is defined as the difference between the incoming signal strength and the modem's receiver sensitivity.

- 3 LEDs ON = Very Strong Signal (> 30 dB fade margin)
- 2 LEDs ON = Strong Signal (> 20 dB fade margin)
- 1 LED ON = Moderate Signal (> 10 dB fade margin)
- 0 LED ON = Weak Signal (< 10 dB fade margin)

1-01c. USB Port

Standard Type-B USB connector - This port can also be used to power the XTend-PKG-U unit.

1-01d. Power Connector*

7-28 VDC power connector

* NOTE: Disconnect the USB cable before connecting or removing power from the Power Connector. This port does not require power for operation at or below 100 mW, unless the USB port cannot provide 300 mA (for example, when using an un-powered USB hub).

1-02a. Config (Configuration) Switch

The Configuration Switch provides an alternate method for entering into Command Mode. To enter Command Mode at the default RF data rate of the RF modem, depress the Config Switch for two seconds.

1-02b. Antenna Port

The antenna port is a 50Ω RF signal connector for connecting to an external antenna. The connector type is RPSMA (Reverse Polarity SMA) female. The connector has threads on the outside of a barrel and a male center conductor.

Back View

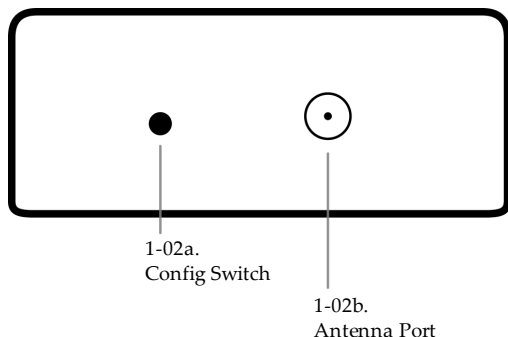

Pin signals

Front View

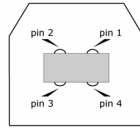

The following table shows the USB Signals and their implementations on the XTend-PKG-U RF Modem.

USB Pin	USB Name	Description	Implementation
1	VBUS	Power	Power RF Modem
2	D-	Transmitted & Received Data	Transmit data to and from the RF Modem
3	D+	Transmitted & Received Data	Transmit data to and from the RF Modem
4	GND	Ground Signal	Ground

Power options

Two power options are available:

- **Self-powered Mode (recommended)** - The device is powered using an external power supply. All TX power levels are supported.
- **Bus-powered Mode** - The device is powered directly from the USB host through the USB cable. TX power levels up to 100mW are supported.

For self-powered mode, use an external power supply that provides a DC voltage between 7 and 28 V. The 9V, 1.1A power supply currently shipped with XTend Development Kits and Accessories Packages is a suitable option.

The device automatically selects self-powered mode if power is available on the power connector when the modem is connected to USB. Do not disconnect the external power source without first disconnecting the modem from the USB connector.

In bus-powered mode, you must limit the power level of the device to 100 mW or below using the PL command. The Legacy modem will issue a warning if transmission is attempted at a power level higher than 100 mW, and the XTend vB modem will issue a warning if transmission is attempted at a power level higher than 500 mW. For more information on warnings, see [WN \(Warning Data\) command](#) on page 54.

Operation



WARNING! When operating at 1 Watt power output, observe a minimum separation distance of 2 m (6 ft) between modems. Transmitting in close proximity of other modems can damage modem front ends.

USB background information

USB has two types of devices: Those that supply drivers (a host, such as a PC); and those that require a driver (a client, such as a Digi USB RF Modem). When a USB client is plugged into a host, the host prompts for a driver. Once a driver is located, the host loads the driver on the first use of the USB client; then reloads the installed driver on all subsequent uses.

A USB client should not be plugged into another client. If another USB client (such as a USB video camera) is plugged into a Digi USB RF modem (also a client), the devices will not communicate. It would be incorrect to attach a USB modem to a host on one end and attach a USB modem to a USB client at the other end. Virtually all USB peripherals (video cameras, PDA cradles, printers, etc.) are USB clients.

Some client devices can act as a host. This is known as “USB on-the-go.” An appropriate USB on-the-go enabled device (such as a PDA with USB on-the-go support) may connect to and utilize a Digi USB RF Modem. Contact Digi for information about device drivers.

Serial communications

Transparent operation

By default, XTend RF Modems operate in Transparent Mode. The modems act as a serial line replacement - all UART data received through the DI pin is queued up for RF transmission. When RF data is received, the data is sent out the DO pin.

When the RO (Packetization Timeout) parameter threshold is satisfied, the modem attempts to initialize an RF transmission. If the modem cannot immediately transmit (for instance, if it is already receiving RF data), the serial data continues to be stored in the DI Buffer. Data is packetized and sent at any RO timeout or when the maximum packet size is received.

The modem operates as described above unless the Command Mode Sequence is detected. The Command Mode Sequence consists of three copies of the command sequence character [CC parameter] surrounded by the before and after guard times [BT and AT parameters].

If the DI buffer becomes full, hardware or software flow control must be implemented in order to prevent overflow (loss of data between the host and modem).

API operation

API (Application Programming Interface) Operation is an alternative to the default Transparent Operation. The API is frame-based and extends the level to which a host application can interact with the networking capabilities of the module. When in API mode, all data entering and leaving the RF modem is contained in frames that define operations or events within the modem.

Transmit Data Frames (received through the DI (Data In) pin) include:

- 16-bit address

Receive Data Frames (sent out the DO (Data Out) pin) include:

- Showing a received RF packet (16 bits only)
- Response to a TX (Transmit) packet
- Showing events such as hardware reset, watchdog reset, asynchronous events, etc.

The modem will send data frames to the application containing status packets; as well as source, RSSI and payload information from received data packets.

API operation option facilitates many operations such as the examples cited below:

- Change destination addresses without having to enter command mode
- Receive success/failure status of each RF packet
- Identify the source address of each received packet

To implement API operations, see [API operation](#) on page 56.

Modes of operation

XTend RF Modems operate in five modes.

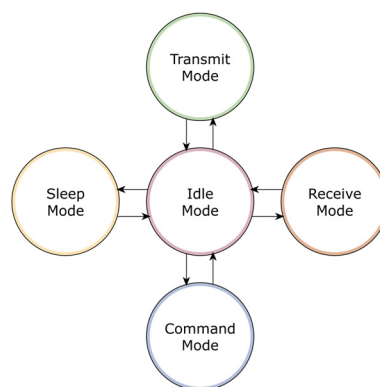

Idle mode

When not receiving or transmitting data, the RF modem is in Idle Mode. The modem shifts into the other modes of operation under the following conditions:

- Transmit Mode (Serial data is received in the DI Buffer)
- Receive Mode (Valid RF data is received through the antenna)
- Sleep Mode (Sleep Mode condition is met)
- Command Mode (Command Mode Sequence is issued)

Transmit mode

When the first byte of serial data is received from the UART in the DI buffer, the modem attempts to shift to Transmit Mode and initiate an RF connection with other modems. After transmission is complete, the modem returns to Idle Mode.

RF transmission begins after either of the following criteria is met:

1. RB bytes have been received by the UART and are pending for RF transmission. Refer to the RB (Packetization Threshold) Command.
2. At least one character has been received by the UART and is pending for RF transmission; and RO character times of silence been observed on the UART. Refer to the RO (Packetization Timeout) Command.

The following diagram shows the Transmit Mode Data Flow.

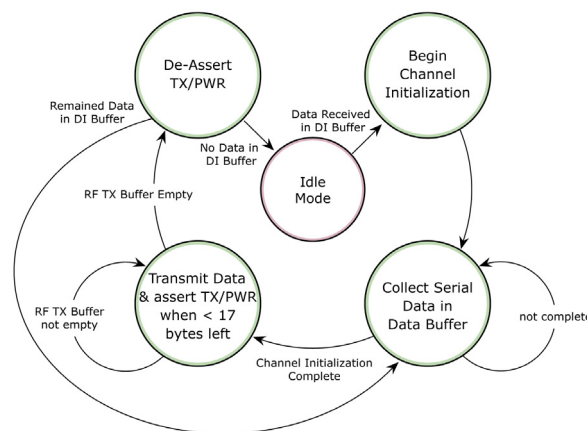

The character timeout trigger can be disabled by setting RO to zero. In this case, transmission will not begin until RB bytes have been received and are pending for RF transmission. The RB parameter may be set to any value between 1 and the RF packet size [refer to PK (Max RF Packet Size) parameter], inclusive. Note that transition to Transmit Mode cannot take place during RF reception; the RF reception must complete before the radio can transition into Transmit Mode.

If RB or RO conditions are met, the modem initializes a communications channel. Serial data in the DI buffer is grouped into RF packets (up to 2048 bytes in each packet, refer to PK Command), converted to RF data and is transmitted over-the-air until the DI buffer is empty.

Channel initialization is the process of sending an RF initializer that synchronizes receiving modems with the transmitting modem. During channel initialization, incoming serial data accumulates in the DI buffer.

RF data, which includes the payload data, follows the RF initializer. The payload includes up to the maximum packet size (PK Command) bytes. As the TX modem nears the end of the transmission, it inspects the DI buffer to see if more data exists to be transmitted. This could be the case if more than PK bytes were originally pending in the DI buffer or if more bytes arrived from the UART after the transmission began. If more data is pending, the transmitting modem assembles a subsequent packet for transmission.

Refer to the ‘RF Communication Modes’ section to view state diagrams that illustrate channel initialization and the sequence of events that follow.

RF packet

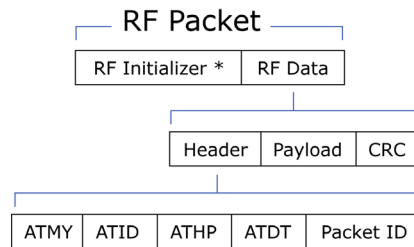

* When streaming multiple RF packets, the RF Initializer is only sent in front of the first packet.

RF initializer

An RF initializer is sent each time a new connection sequence begins. The RF initializer contains channel information that notifies receiving modems of information such as the hopping pattern used by the transmitting modem. The first transmission always sends an RF initializer.

An RF initializer can be of various lengths depending on the amount of time determined to be required to prepare a receiving modem. For example, a wake-up initializer is a type of RF initializer used to wake remote modems from Sleep Mode (Refer to the FH, LH, HT and SM Commands for more information). The length of the wake-up initializer should be longer than the length of time remote modems are in cyclic sleep.

Header

The header contains network addressing information that filters incoming RF data. The receiving modem checks for matching a Hopping Channel, VID and Destination Address. Data that does not pass through all three network filter layers is discarded.

Refer to the ‘Addressing’ section of the “RF Communication Modes” chapter for more information.

CRC (Cyclic Redundancy Check)

To verify data integrity and provide built-in error checking, a 16-bit CRC (Cyclic Redundancy Check) is computed for the transmitted data and attached to the end of each RF packet. On the receiving end, the receiving modem computes the CRC on all incoming RF data. Received data that has an invalid CRC is discarded [refer to the ‘Receive Mode’ section].

Receive mode

If a modem detects RF data while operating in Idle Mode, the modem transitions to Receive Mode to start receiving RF packets. Once a packet is received, the modem checks the CRC (cyclic redundancy check) to ensure that the data was transmitted without error. If the CRC data bits on the incoming packet are invalid, the packet is discarded. If the CRC is valid, the packet proceeds to the DO Buffer.

The following figure shows the Receive Mode Data Flow.

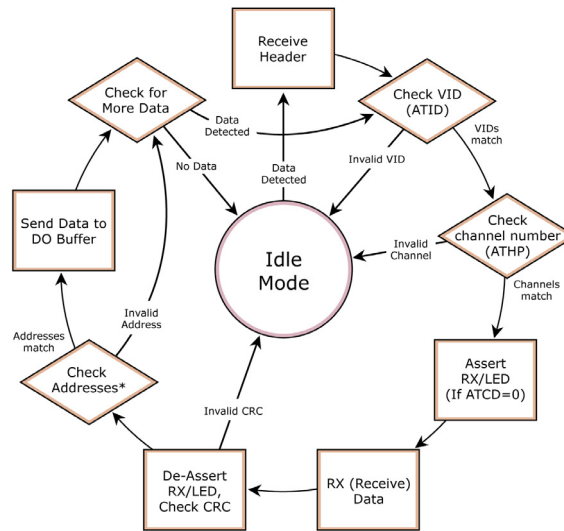

* Refer to the 'Address Recognition' section for more information regarding address recognition.

The modem returns to Idle Mode when valid RF data is no longer detected or after an error is detected in the received RF data. If serial data is stored in the DI buffer while the modem is in Receive Mode, the serial data will be transmitted after the modem is finished receiving data and returns to Idle Mode.

Sleep mode

Software sleep

Sleep Modes enable the modem to enter states of low-power consumption when not in use. Three software Sleep Modes are supported:

- Pin Sleep (Host Controlled)
- Serial Port Sleep (Wake on Serial Port activity)
- Cyclic Sleep (Wake on RF activity)

In order to enter Sleep Mode, one of the following conditions must be met (in addition to the modem having a non-zero SM parameter value):

1. The modem is idle (no data transmission or reception) for the amount of time defined by the ST (Time before Sleep) parameter.

Note ST is only active when SM = 4-5.

2. GPI2 (SLEEP) is asserted (only for the 'Pin Sleep' option).

When in Sleep Mode, the modem will not transmit or receive data until the modem first transitions to Idle Mode. All Sleep Modes are enabled and disabled using SM Command. Transitions into and out of Sleep Modes are triggered by various mechanisms as shown in the table below.

Sleep Mode (Setting)	Transition into Sleep Mode	Transition out of Sleep Mode (wake)	Related Commands	Power Consumption
Pin Sleep (SM = 1)	Assert GPI2 pin - A micro controller can shut down and wake modems via the GPI2 pin. Note: The modem will complete a transmission or reception before activating Pin Sleep.	De-assert GPI2 pin	(SM)	See Power requirements on page 8
Serial Port Sleep (SM = 2)	Automatic transition to Sleep Mode occurs after a user-defined period of inactivity (no transmitting or receiving of data). Period of inactivity is defined by the ST (Time before Sleep) Command.	When a serial byte is received on the DI pin	(SM), ST	See Power requirements on page 8
Cyclic Sleep (SM = 4 - 8)	RF modem transitions in and out of Sleep Mode in cycles (user-selectable wake-up interval of time is set using the SM command). The cyclic sleep interval of time must be shorter than the interval of time that is defined by the LH (Wake-up Initializer Timer) command. Note: The modem can be forced into Idle Mode using the GPI2 pin if the PW (Pin Wake-up) command is issued.		(SM), ST, HT, LH, PW	See Power requirements on page 8

The SM (Sleep Mode) command is central to setting all Sleep Mode configurations. By default, Sleep Modes are disabled (SM = 0) and the modem remains in Idle/Receive Mode. When in this state, the modem remains constantly ready to respond to serial or RF activity.

Pin Sleep (SM = 1)

- Pin/Host-controlled

This mode is voltage level activated. When the GPI2 pin is asserted, the modem will finish any transmitting or receiving activity; enter Idle Mode; then enter a state of sleep. When in Pin Sleep Mode, the modem will not respond to serial or RF activity.

After enabling Pin Sleep, the GPI2 pin controls whether the modem is active or sleeping. When GPI2 is de-asserted, the modem is fully operational. When GPI2 is asserted, the modem transitions to Sleep Mode and remains in its lowest power-consuming state until the pin is de-asserted. This pin is only active if the modem is setup to operate in this mode; otherwise the pin is ignored.

Once in Pin Sleep, $\overline{\text{CTS}}$ (GPO1) is de-asserted (high), indicating that data should not be sent to the modem. The PWR pin is also de-asserted (low) when the modem is in Pin Sleep Mode.

Note: The modem will complete a transmission or reception before activating Pin Sleep.

Serial Port Sleep (SM = 2)

- Wake on serial port activity

Serial Port Sleep is a Sleep Mode in which the modem runs in a low power state until serial data is detected on the DI pin.

The period of time the modem sleeps is determined by ST (Time before Sleep) Command. Once a character is received through the DI pin, the modem returns to Idle Mode and is fully operational.

Cyclic Sleep (SM = 4-8)

Cyclic Sleep Modes allow modems to periodically wake and check for RF data. The modem wakes according to the times designated by the Cyclic sleep settings. If the modem detects a wake-up initializer during the time it is awake, the modem synchronizes with the transmitting modem and receives data after the wake-up initializer runs its duration. Otherwise, the modem returns to Sleep Mode and continues to cycle in and out of activity until a wake-up initializer is detected.

While the modem is in Cyclic Sleep Mode, $\overline{\text{CTS}}$ (GPO1) is de-asserted (high) to indicate that data should not be sent to the modem. When the modem awakens to listen for data, GPO1 is asserted and any data received on the DI Pin is transmitted. The PWR pin is also de-asserted (low) when the modem is in Cyclic Sleep Mode.

The modem remains in Sleep Mode for a user-defined period of time ranging from 0.5 seconds to 16 seconds (SM parameters 4 through 8). After this interval of time, the modem returns to Idle Mode and listens for a valid data packet for 100 ms. If the modem does not detect valid data (on any frequency), the modem returns to Sleep Mode. If valid data is detected, the modem transitions into Receive Mode and receives the incoming RF packets. The modem then returns to Sleep Mode after a period of inactivity determined by the ST "Time before Sleep" parameter.

The modem can also be configured to wake from cyclic sleep when the GPI2 pin is de-asserted. To configure a modem to operate in this manner, PW (Pin Wake-up) Command must be issued. Once the GPI2 pin is de-asserted, the modem is forced into Idle Mode and can begin transmitting or receiving data. It remains active until data is no longer detected for the period of time specified by the ST Command, at which point it resumes its low-power cyclic state.

Cyclic scanning

Each RF transmission consists of an RF Initializer and payload. The RF initializer contains initialization information and all receiving modems must wake during the wake-up initializer portion of data transmission in order to be synchronized with the transmitting modem and receive the data.

The cyclic interval time defined by the SM (Sleep Mode) command must be shorter than the interval time defined by LH (Wake-up Initializer Timer) command.

The following figure shows the Correct Configuration (LH > SM):

The length of the wake-up initializer exceeds the time interval of Cyclic Sleep. The receiver is guaranteed to detect the wake-up initializer and receive the accompanying payload data.

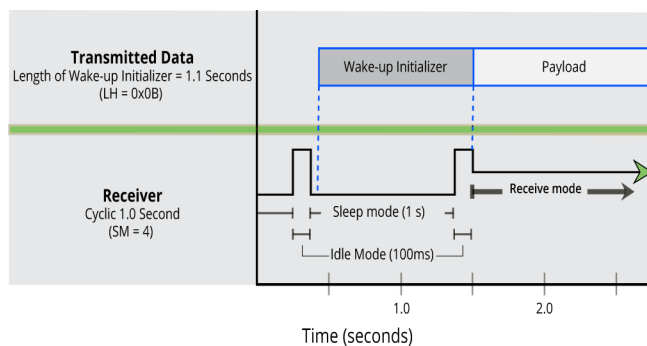

Command mode

To modify or read modem parameters, the modem must first enter into Command Mode (state in which incoming characters are interpreted as commands). Two command types are supported:

- AT Commands

- Binary Commands

For modified parameter values to persist in the modem registry, changes must be saved to non-volatile memory using the WR (Write) command. Otherwise, parameters are restored to previously saved values when the modem is powered off and then on again.

AT Command mode

To Enter AT Command mode:

1. Send the 3-character command sequence "+++" and observe guard times before and after the command characters. [refer to 'Default AT Command Mode Sequence' below.] The 'Terminal' tab (or other serial communications software) of the XCTU Software can be used to enter the sequence.
[OR]
2. Assert (low) the $\overline{\text{CONFIG}}$ pin and turn the power going to the modem off and back on (or pulse the $\overline{\text{SHDN}}$ pin).

[If the modem is mounted to a Digi RS-232/485 Interface Board, the result can be achieved by pressing the configuration switch down for 2 seconds.]

Default AT Command Mode Sequence (for transition to Command Mode):

- No characters sent for one second [refer to the BT (Guard Time Before) Command]
- Input three plus characters ("+++") within one second [refer to the CC (Command Sequence Character) Command.]
- No characters sent for one second [refer to the AT (Guard Time After) Command.]

All of the parameter values in the sequence can be modified to reflect user preferences.

Send AT commands

Send AT commands and parameters using the syntax shown below.

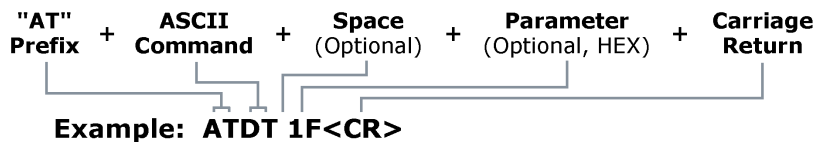

To read a parameter value stored in the modem register, leave the parameter field blank.

The preceding example would change the modem's Destination Address to "0x1F". To store the new value to non-volatile (long term) memory, the Write (ATWR) command must subsequently be sent before powering off the modem.

When a command is sent to the modem, the modem will parse and execute the command. Upon successful execution of a command, the modem returns an "OK" message. If execution of a command results in an error, the modem returns an "ERROR" message.

To Exit AT Command Mode:

1. If no valid AT Commands are received within the time specified by CT (Command Mode Timeout) Command, the modem automatically returns to Idle Mode.
[OR]
2. Send ATCN (Exit Command Mode) Command.

For an example of programming the RF modem using AT Commands and descriptions of each configurable parameter, see [Use XCTU to configure the RF Modem](#) on page 23.

Binary Command mode

Sending and receiving parameter values using binary commands is the fastest way to change operating parameters of the modem. Binary commands are used most often to sample signal strength [refer to DB (Received Signal Strength) parameter] and/or error counts; or to change modem addresses and channels for polling systems when a quick response is necessary. Since the sending and receiving of parameter values takes place through the same serial data path as 'live' data (received RF payload), interference between the two types of data can be a concern.

Common questions about using binary commands:

- What are the implications of asserting CMD while live data is being sent or received?
- After sending serial data, is there a minimum time delay before CMD can be asserted?
- Is a time delay required after CMD is de-asserted before payload data can be sent?
- How does one discern between live data and data received in response to a command?

The CMD pin (GPI1) must be asserted in order to send binary commands to the modem. The CMD pin can be asserted to recognize binary commands anytime during the transmission or reception of data. The status of the CMD signal is only checked at the end of the stop bit as the byte is shifted into the serial port. The application does not allow control over when data is received, except by waiting for dead time between bursts of communication.

If the command is sent in the middle of a stream of payload data to be transmitted, the command will essentially be executed in the order it is received. If the modem is continuously receiving data, the radio will wait for a break in the received data before executing the command. The $\overline{\text{CTS}}$ signal will frame the response coming from the binary command request [refer to figure below].

A minimum time delay of 100 μs (after the stop bit of the command byte has been sent) must be observed before the CMD pin can be de-asserted. The command executes after all parameters associated with the command have been sent. If all parameters are not received within 0.5 seconds, the modem returns to Idle Mode.

Note: When parameters are sent, they are two bytes long with the least significant byte sent first. Binary commands that return one parameter byte must be written with two parameter bytes.

Commands can be queried for their current value by sending the command logically ORed (bit-wise) with the value 0x80 (hexadecimal) with CMD asserted. When the binary value is sent (with no parameters), the current value of the command parameter is sent back through the DO pin.

Binary Command Write then Read

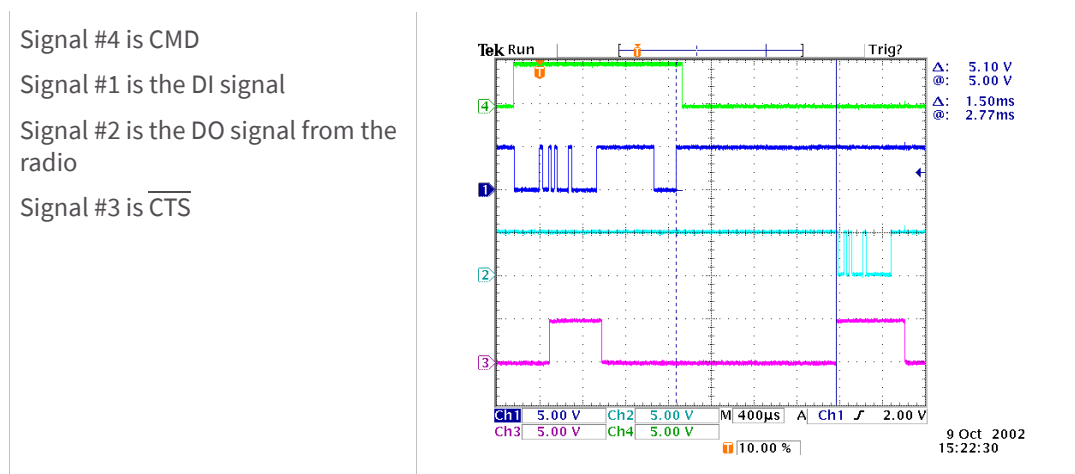

In this graph, a value was written to a register and then read out to verify it. While not in the middle of other received data, note that the $\overline{\text{CTS}}$ signal outlines the data response out of the modem.

IMPORTANT: In order for the modem to recognize a binary command, the RT (GPI1 Configuration) parameter must be set to one. If binary programming is not enabled (RT parameter value is not equal to '1'), the modem will not recognize that the CMD pin is asserted and therefore will not recognize the data as binary commands.

For a binary programming example, see [Binary commands](#) on page 24 (DT command example returns two bytes).

Configure the RF Modem

Refer to [Command mode](#) on page 19 for information regarding entrance into Command Mode, sending AT commands and exiting Command Mode.

Use XCTU to configure the RF Modem

XBee Configuration and Test Utility (XCTU) is a multi-platform program that enables developers to interact with Digi radio frequency (RF) devices through a graphical interface. The application includes built-in tools that make it easy to set up, configure, and test Digi RF devices.

For instructions on downloading and using XCTU, go to:

<http://www.digi.com/products/xbee-rf-solutions/xctu-software/xctu>

Refer to the online help for XCTU for more information on the program and how to use it. The help information is available at:

<https://docs.digi.com/display/XCTU/XCTU+Overview>

Load default firmware settings

In XCTU, you can load default module firmware settings onto a module in your device list. To load default firmware settings:

1. Switch to Configuration working mode.
2. Select a module from the device list. XCTU displays the current firmware settings for that module.
3. From the Configuration toolbar, click the **Load default firmware settings** button to load the default values established by the firmware.
4. Firmware settings are loaded but not written to the module. In order to write them in the module, click the **Write module settings** button on the toolbar.

Note You can also load default firmware settings with the Firmware explorer tool, but the tool does not have write functionality.

CAUTION! Do not send commands to the modem during flash programming (when parameters are being written to the modem registry).

Binary commands

To Send Binary commands:

Example: Use binary commands to change the RF modem's destination address to 0x1A0D and save the new address to non-volatile memory.

1. RT Command must be set to '1' in AT Command Mode to enable binary programming.
2. Assert CMD (Pin 10 is driven high). (Enter Binary Command Mode)
3. Send Bytes [parameter bytes must be 2 bytes long]:

00	(Send DT (Destination Address) Command)
0D	(Least significant byte of parameter bytes)
1A	(Most significant byte of parameter bytes)
08	(Send WR (Write) Command)
4. De-assert CMD (GPI1 is driven low). (Exit Binary Command Mode)

Note $\overline{\text{CTS}}$ (GPO1) is high when a command is being executed. Hardware flow control must be disabled as $\overline{\text{CTS}}$ will hold off parameter bytes.

Command reference table

This AT command information is provided for reference. For additional details, refer to the XTend and XTend vB RF module user's guides.

XTend Commands (The RF modems expect numerical values in hexadecimal. Hexadecimal values are designated by a “0x” prefix. Decimal equivalents are designated by a “d” suffix.)

AT Command	Binary Command	AT Command Name	Parameter Range	Command Category	# Bytes Returned	Factory Default
%V	0x3B (59d)	Board Voltage	0x2CCCA - 0x5BFFA [read-only]	Diagnostics	4	--
AM	0x40 (64d)	Auto-set MY	--	Networking and Security	--	--
AP v2.x20*	--	API Enable	0 - 2	Serial Interfacing	1	0
AT	0x05 (5d)	Guard Time After	2 - (ATST-3) [x 100 msec]	Command Mode Options	2	0x0A (10d)
BD	0x15 (21d)	Interface Data Rate	0 - 8 (standard rates) 0x39 - 0x1C9C38 (Legacy Modem non-standard rates) 0x4B0 - 0x2580 and 0x4B00 - 0x1C9468 (XTend vB Modem non-standard rates)	Serial Interfacing	4	3
BR	0x39 (57d)	RF Data Rate	0 - 1	RF Interfacing	1	2
BT	0x04 (4d)	Guard Time Before	0 - 0xFFFF [x 100 msec]	Command Mode Options	2	0x0A (10d)
CC	0x13 (19d)	Command Sequence Character	0x20 - 0x7F	Command Mode Options	1	0x2B [“+”] (43d)
CD	0x28 (40d)	GPO2 Configuration	0 - 4	Serial Interfacing	1	2
CF	--	Number Base	0 - 2	Command Mode Options	1	1
CN	0x09 (9d)	Exit Command Mode	--	Command Mode Options	--	--
CS	0x1F (31d)	GPO1 Configuration	0 - 4	Serial Interfacing	1	0
CT	0x06 (6d)	Command Mode Timeout	2 - 0xFFFF [x 100 ms]	Command Mode Options	2	0xC8 (200d)
DB	0x36 (54d)	Received Signal Strength	0x6E - 0x28 [read-only]	Diagnostics	2	--
DT	0x00 (0d)	Destination Address	0 - 0xFFFF	Networking and Security	2	0
E0	0x0A (10d)	Echo Off	--	Command Mode Options	--	--

AT Command	Binary Command	AT Command Name	Parameter Range	Command Category	# Bytes Returned	Factory Default
E1	0x0B (11d)	Echo On	--	Command Mode Options	--	--
ER	0x0F (15d)	Receive Error Count	0 - 0xFFFF	Diagnostics	2	0
FH	0x0D (13d)	Force Wake-up Initializer	--	Sleep (Low Power)	--	--
FL	0x07 (7d)	Software Flow Control	0 - 1	Serial Interfacing	1	0
FS	0x3E (62d)	Forced Sync Time	0 - 0xFFFF [x 10 msec]	RF Interfacing	2	0
FT	0x24 (36d)	Flow Control Threshold	0 - (DI buffer size - 0x11) [Bytes]	Serial Interfacing	2	DI buffer size minus 0x11
GD	0x10 (16d)	Receive Good Count	0 - 0xFFFF	Diagnostics	2	0
HP	0x11 (17d)	Hopping Channel	0 - 9	Networking and Security	1	0
HT	0x03 (3d)	Time before Wake-up Initializer	0 - 0xFFFF [x 100 msec]	Sleep (Low Power)	2	0xFFFF (65535d)
HV	--	Hardware Version	0 - 0xFFFF [read-only]	Diagnostics	2	--
ID	0x27 (39d)	Modem VID	0x11 - 0x7FFF (user-settable) 0x8000 - 0xFFFF (factory-set, read-only)	Networking and Security	2	0x3332 (13106d)
KY	0x3C (60d)	AES Encryption Key	0 - (Any other 64-digit hex valid key)	Networking and Security	2	0
LH	0x0C (12d)	Wake-up Initializer Timer	0 - 0xFF [x 100 msec]	Sleep (Low Power)	1	1
MD v2.x20*	0x31 (49d)	RF Mode	0 - 6	Networking and Security	1	0
MK	0x12 (18d)	Address Mask	0 - 0xFFFF	Networking and Security	2	0xFFFF (65535d)
MT	0x3D (61d)	Multi-Transmit	0 - 0xFF	Networking and Security	1	0
MY	0x2A (42d)	Source Address	0 - 0xFFFF	Networking and Security	2	0xFFFF (65535d)
NB	0x23 (35d)	Parity	0 - 4	Serial Interfacing	1	0
PB v2.x20*	0x45 (69d)	Polling Begin Address	0 - 0xFFFF	Networking and Security	2	0

AT Command	Binary Command	AT Command Name	Parameter Range	Command Category	# Bytes Returned	Factory Default
PD v2.x20*	0x47 (71d)	Minimum Polling Delay	0 - 0xFFFF (Base: (x 1 ms), Remote: [x 10 ms])	Networking and Security	2	0
PE v2.x20*	0x46 (70d)	Polling End Address	0 - 0xFFFF	Networking and Security	2	0
PK	0x29 (41d)	Maximum RF Packet Size	1 - 0x800 [Bytes]	RF Interfacing	2	varies
PL	0x3A (58d)	TX Power Level	0 - 4	RF Interfacing	1	4 (1 Watt)
PW	0x1D (29d)	Pin Wake-up	0 - 1	Sleep (Low Power)	1	0
RB	0x20 (32d)	Packetization Threshold	1 - Current value of PK	Serial Interfacing	2	0x800 (2048d)
RC	--	Ambient Power - Single Channel	0 - 0x31 [dBm, read-only]	Diagnostics	1	--
RE	0x0E (14d)	Restore Defaults	--	(Special)	--	--
RM	--	Ambient Power - All Channels	No parameter - 0x7D0	Diagnostics	2	--
RN	0x19 (25d)	Delay Slots	0 - 0xFF [slots]	Networking and Security	1	0
RO	0x21 (33d)	Packetization Timeout	0 - 0xFFFF [x UART character time]	Serial Interfacing	2	3
RP	0x22 (34d)	RSSI PWM Timer	0 - 0xFF [x 100 msec]	Diagnostics	1	0x20 (32d)
RR	0x18 (24d)	Retries	0 - 0xFF	Networking and Security	1	0x0A (10d)
RT	0x16 (22d)	GPI1 Configuration	0 - 2	Serial Interfacing	1	0
SB	0x37 (55d)	Stop Bits	0 - 1	Serial Interfacing	1	0
SH	0x25 (37d)	Serial Number High	0 - 0xFFFF [read-only]	Diagnostics	2	varies
SL	0x26 (38d)	Serial Number Low	0 - 0xFFFF [read-only]	Diagnostics	2	varies
SM	0x01 (1d)	Sleep Mode	0 - 8 (3 is reserved)	Sleep (Low Power)	1	0
ST	0x02 (2d)	Time before Sleep	(ATAT+3) - 0x7FFF [x 100 msec]	Sleep (Low Power)	2	0x64 (100d)
TP	0x38 (56d)	Board Temperature	0 - 0x7F [read-only]	Diagnostics	1	--
TR	0x1B (27d)	Delivery Failure Count	0 - 0xFFFF [read-only]	Diagnostics	2	0
TT	0x1A (26d)	Streaming Limit	0 - 0xFFFF [0 = disabled]	Networking and Security	2	0

AT Command	Binary Command	AT Command Name	Parameter Range	Command Category	# Bytes Returned	Factory Default
TX	0x3F (63d)	Transmit Only	0 - 1	RF Interfacing	1	0
VL	--	Firmware Version - verbose	Returns string	Diagnostics	--	--
VR	0x14 (20d)	Firmware Version	0 - 0xFFFF [read-only]	Diagnostics	2	--
WA	--	Active Warning Numbers	Returns string	Diagnostics	--	--
WN	--	Warning Data	Returns string	Diagnostics	--	--
WR	0x08 (8d)	Write	--	(Special)	--	--
WS	--	Sticky Warning Numbers	Returns string	Diagnostics	--	--

* Firmware version in which command and parameter options were first supported.

Command descriptions

Commands in this section are listed alphabetically. Command categories are designated between the "<>" symbols that follow each command title. By default, XTend RF Modems expect numerical values in hexadecimal since the default value of the CF (Number Base) Parameter is '1'. Hexadecimal values are designated by the "0x" prefix and decimal values by the "d" suffix.

%V (Board Voltage) Command

<Diagnostics> %V Command is used to read the current voltage of the modem circuit board.

Sample Output:

```
5.02 V (when ATCF = 0)
5051F (when ATCF = 1) *
5.02 (when ATCF = 2)
```

* When CF = 1 (default), a hex integer is shown that is equal to (voltage * 65536d).

AT Command: AT%V
Binary Command: 0x3B (59 decimal)
Parameter Range (read-only): 0x2CCCA - 0x5BFFA (2.80 - 5.75 decimal)
Number of bytes returned: 4

AM (Auto-set MY) Command

AT Command: ATAM
Binary Command: 0x40 (64 decimal)

<Networking and Security> AM Command is used to automatically set the MY (Source Address) parameter from the factory-set serial number of the modem. The address is formed with bits 29, 28 and 13-0 of the serial number (in that order). The resulting value is displayed as a result of this command.

AP (API Enable) command

<Serial Interfacing> The AP command is used to enable the modem to operate using the frame-based API operation.

AT Command: ATAP		
Parameter Range:0 - 2		
	Parameter	Configuration
	0	API Disabled (Transparent Operation)
	1	API enabled (w/out escaped characters)
	2	API enabled (with escaped characters)
Default Parameter Value:0		
Number of Bytes Returned:1		
Legacy Modem Minimum Firmware Version Required: 2.x20		

AT (Guard Time After) command

<Command Mode Options> AT Command is used to set/read the time-of-silence that follows the command sequence character (CC Command) of the AT Command Mode Sequence (BT + CC + AT). By default, 1 second must elapse before and after the command sequence character.

The times-of-silence surrounding the command sequence character are used to prevent inadvertent entrance into AT Command Mode.

AT Command: ATAT
Binary Command: 0x05 (5 decimal)
Parameter Range:2 - (ATST-3), up to 0x7FFC [x 100 milliseconds]
Default Parameter Value: 0x0A (10 decimal)
Number of bytes returned: 2
Related Commands: BT (Guard Time Before), CC (Command Sequence Character)

BD (Interface Data Rate) command

<Serial Interfacing> The BD command is used to set and read the serial interface data rate (baud rate) used between the RF modem and host. This parameter determines the rate at which serial data is sent to the modem from the host. Modified interface data rates do not take effect until the CN (Exit AT Command Mode) command is issued and the system returns the 'OK' response.

When parameters 0-8 are sent to the modem, the respective interface data rates are used (as shown in the table on the right).

The RF data rate is not affected by the BD parameter. If the interface data rate is set higher than the RF data rate, a flow control configuration may need to be implemented.

The range between standard and non-standard baud rates is invalid.

AT Command: ATBD		
Binary Command: 0x15 (21 decimal)		
Parameter Ranges: 0 - 8 (standard rates) 0x39 - 0x1C9C38 (Legacy Modem non-standard rates) 0x4B0 - 0x2580 and 0x4B00 - 0x1C9468 (XTend vB Modem non-standard rates)		
	Parameter	Configuration (b/s)
	0	1200
	1	2400
	2	4800
	3	9600
	4	19200
	5	38400
	6	57600
	7	115200
	8	230400
Default Parameter Value: 3		
Legacy Modem Non-standard baud rates supported as of firmware v2.x20		
Number of bytes returned: 4		

Non-standard Interface Data Rates

BD values above 0x38 (Legacy) or 0x4AF (XTend vB) are interpreted as an actual baud rate. When a non-standard value is sent, the closest interface data rate represented by the number is stored in the BD register. For example, a rate of 19200 b/s can be set by sending the following command line "ATBD4B00".

Note on Legacy only: when the BD command is sent with a non-standard interface data rate, the UART will adjust to accommodate the requested interface rate. In most cases, the clock resolution will cause the stored BD parameter to vary from the parameter that was sent. Reading the BD command (send the "ATBD" command without an associated parameter value) will return the value actually stored in the modem's BD register.

BR (RF Data Rate) command

<RF Interfacing> The BR command is used to set and read the RF data rate (rate that RF data is transmitted over-the-air) of the modem.

AT Command: ATBR
Binary Command: 0x39 (57 decimal)
Parameter Range: 0 - 1

AT Command: ATBR		
	Parameter	RF data rate
	0	10 kb/s
	1	125 kb/s
Default Parameter Value: 2		
Number of bytes returned: 1		

BT (Guard Time Before) command

<AT Command Mode Options> The CC command is used to set/read the ASCII character used between guard times of the AT Command Mode Sequence (BT + CC + AT). This sequence enters the modem into AT Command Mode so that data entering the modem (from the host) is recognized as commands instead of payload.

AT Command: ATCC
Binary Command: 0x13 (19 decimal)
Parameter Range: 0x20 - 0x7F
Default Parameter Value: 0x2B (ASCII "+")
Number of bytes returned: 1
Related Commands: AT (Guard Time After), BT (Guard Time Before)

CC (Command Sequence Character) command

<AT Command Mode Options> The CC command is used to set/read the ASCII character used between guard times of the AT Command Mode Sequence (BT + CC + AT). This sequence enters the modem into AT Command Mode so that data entering the modem (from the host) is recognized as commands instead of payload.

AT Command: ATCC
Binary Command: 0x13 (19 decimal)
Parameter Range: 0x20 - 0x7F
Default Parameter Value: 0x2B (ASCII "+")
Number of bytes returned: 1
Related Commands: AT (Guard Time After), BT (Guard Time Before)

CD (GPO2 Configuration) Command

<Serial Interfacing> CD Command is used to select/read the behavior of the GPO2 line (pin 3).

AT Command: ATCD		
Binary Command: 0x28 (40 decimal)		
Parameter Range: 0 - 8 (standard rates)		
	Parameter	Configuration
	0	RX LED
	1	Default High
	2	Default Low
	3	(reserved)
	4	RX LED (valid address only)
Default Parameter Value: 2		
Number of bytes returned: 1		

CF (Number Base) Command

<Command Mode Options> CF command is used to set/read the command formatting setting.

The following commands are always entered and read in hex, no matter the CF setting:

VR (Firmware Version)
 HV (Hardware Version)
 KY (AES Encryption Key)

AT Command: ATCF		
Parameter Range: 0 – 2		
	Parameter	Configuration
	0	Commands utilize default number base; decimal commands may output units
	1	All commands forced to unsigned, unit-less hex
	2	Commands utilize their default number base; no units are output
Default Parameter Value: 1		
Number of bytes returned: 1		

CN (Exit AT Command Mode) Command

<Command Mode Options> The CN command is used to explicitly exit the modem from AT Command Mode.

AT Command: ATCN
Binary Command: 0x09 (9 decimal)

CS (GPO1 Configuration) Command

<Serial Interfacing> CS Command is used to select the behavior of the GP01 pin (pin 9). This output can provide RS-232 flow control, control the TX enable signal (for RS-485 or RS-422 operations).

By default, GP01 provides RS-232 $\overline{\text{CTS}}$ (Clear-to-Send) flow control.

AT Command: ATCS		
Binary Command: 0x1F (31 decimal)		
Parameter Range: 0 - 4		
	Parameter	Configuration
	0	RS-232 $\overline{\text{CTS}}$ flow control
	1	RS-485 TX enable low
	2	High
	3	RS-485 TX enable high

AT Command: ATCS	
4	Low
Default Parameter Value: 0	
Number of bytes returned: 1	
Related Commands: RT (GPI1 Configuration), TO (GP01 Timeout)	

CT (Command Mode Timeout) Command

<Command Mode Options> The CT command is used to set and read the amount of inactive time that elapses before the modem automatically exits from AT Command Mode and returns to Idle Mode.

Use the CN (Exit AT Command Mode) command to exit AT Command Mode manually.

AT Command: ATCT	
Binary Command: 0x06 (6 decimal)	
Parameter Range: 2 - 0xFFFF [x 100 milliseconds]	
Default Parameter Value: 0xC8 (200d)	
Number of bytes returned: 2	
Related Command: CN (Exit AT Command Mode)	

DB (Received Signal Strength) Command

<Diagnostics> DB Command is used to read the receive signal strength (in decibels relative to milliwatts) of the last received packet. This parameter is useful in determining range characteristics of the RF modems under various conditions.

In default mode, this command shows the power level in signed decimal format with the units (dBm). If CF = 1, the magnitude of the value is presented in unsigned hex. If CF = 2, the value is presented in decimal, but without the units.

Sample Output:

```
-88 dBm (when ATCF = 0)
58      (when ATCF = 1)
-88     (when ATCF = 2)
```

Note If the DB register is read before the modem has received an RF packet, the modem will return a value of 0x8000 (which means an RF packet has not yet been received).

AT Command: ATDB	
Binary Command: 0x36 (54 decimal)	
Parameter Range (read-only): 0x6E - 0x28 (-110 to -40 Decimal)	
Number of bytes returned: 2	

DT (Destination Address) Command

<Networking and Security> DT Command is used to set/read the networking address of an RF modem. The modems utilize three filtration layers: Vendor ID Number (ATID), Channel (ATHP), and Destination Address (ATDT). The DT command assigns an address to a modem that enables it to communicate only with other modems having the same address. All modems that share the same DT parameter can communicate with each other.

RF modems in the same network with a different destination address (than that of the transmitter) will listen to all transmissions to stay synchronized, but will not send any of the data out their serial ports.

AT Command: ATDT
Binary Command: 0x00
Parameter Range: 0 - 0xFFFF
Default Parameter Value: 0
Number of bytes returned: 2
Related Commands: HP (Hopping Channel), ID (Modem VID), MK (Address Mask), MY (Source Address)

E0 (Echo Off) Command

<Command Mode Options> E0 Command turns off character echo in AT Command Mode.

By default, echo is off.

AT Command: ATE0
Binary Command: 0x0A (10 decimal)

E1 (Echo On) Command

<Command Mode Options> E1 Command enables character echo in AT Command Mode. Each typed character will be echoed back to the terminal when ATE1 is active. E0 (Echo Off) is the default.

AT Command: ATE1
Binary Command: 0x0B (11 decimal)

ER (Receive Error Count) Command

<Diagnostics> The ER command is used to set/read the number of receive-errors. The error count records the number of packets partially received then aborted on a reception error. This value returns to 0 after a reset and is not non-volatile (Value does not persist in the modem's memory after a power-up sequence). Once the Receive Error Count reaches its maximum value (up to 0xFFFF), it remains at its maximum count value until the maximum count value is explicitly changed or the modem is reset.

The ER parameter is not reset by pin, serial port or cyclic sleep modes.

AT Command: ATER
Binary Command: 0x0F (15 decimal)
Parameter Range: 0 - 0xFFFF
Default Parameter Value: 0
Number of bytes returned: 2
Related Commands: GD (Receive Good Count)

FH (Force Wake-up Initializer) Command

<Sleep (Low Power)> The FH command is used to force a Wake-up Initializer to be sent on the next transmission. Use only with cyclic sleep modes active on remote modems.

ATFH will not send a long header if ATHT = 0xFFFF. WR (Write) Command does not need to be issued with FH Command.

AT Command: ATFH
Binary Command: 0x0D (13 decimal)

FL (Software Flow Control) Command

<Serial Interfacing> The FL command is used to configure software flow control. Hardware flow control is implemented with the modem as the GP01 pin (CTS pin of the OEM RF module), which regulates when serial data can be transferred to the modem.

FL Command can be used to allow software flow control to also be enabled. The XON character used is 0x11 (17 decimal). The XOFF character used is 0x13 (19 decimal)

AT Command: ATFL		
Binary Command: 0x07 (7 decimal)		
Parameter Range: 0 - 1		
	Parameter	Configuration
	0	Disable software flow control
	1	Enable software flow control
Default Parameter Value: 0		
Number of bytes returned: 1		

FS (Forced Sync Time) Command

<RF Interfacing> The FS command only applies to streaming data. Normally, only the first packet of a continuous stream contains the full RF initializer. The RF modems then remain synchronized for subsequent packets of the stream. This parameter can be used to periodically force an RF initializer during such streaming. Any break in UART

character reception long enough to drain the DI Buffer (UART receive buffer) and cause a pause in RF data transmission will also cause an RF initializer to be inserted on the next transmission.

AT Command: ATFS
Binary Command: 0x3E (62 decimal)
Parameter Range: 0 - 0xFFFF [x 10 milliseconds]
Default Parameter Value: 0
Number of bytes returned: 2

FT (Flow Control Threshold) Command

<Serial Interfacing> The FT command is used to set/read the flow control threshold. When FT bytes have accumulated in the DI buffer (UART Receive), CTS is de-asserted or the XOFF software flow control character is transmitted.

AT Command: ATFT
Binary Command: 0x24 (36 decimal)
Parameter Range: 0 - (DI buffer size minus 0x11) [Bytes]
Default Parameter Value: DI Buffer size minus 0x11 (17 decimal)
Number of bytes returned: 2

GD (Receive Good Count) Command

<Diagnostics> The GD command is used to set/read the count of good received RF packets. Its parameter value is reset to 0 after every reset and is not non-volatile (The parameter value does not persist in the RF modem's memory after a power-up sequence). Once the "Receive Good Count" reaches its maximum value (up to 0xFFFF), it remains at its maximum count value until the maximum count value is manually changed or the modem is reset.

The GD parameter is not reset by pin, serial port or cyclic sleep modes.

AT Command: ATGD
Binary Command: 0x10 (16 decimal)
Parameter Range: 0 - 0xFFFF
Default Parameter Value: 0
Number of bytes returned: 2
Related Commands: ER (Receive Error Count)

HP (Hopping Channel) Command

<Networking and Security> The HP command is used to set/read the RF modem's hopping channel number. A channel is one of three layers of filtration available to the modem.

In order for modems to communicate with each other, the modems must have the same channel number since each channel uses a different hopping sequence. Different channels can be used to prevent modems in one network from listening to transmissions of another.

AT Command: ATHP
Binary Command: 0x11 (17 decimal)
Parameter Range: 0 - 9
Default Parameter Value: 0
Number of bytes returned: 1
Related Commands: ID (Modem VID), DT (Destination Address), MK (Address Mask)

HT (Time before Wake-up Initializer) Command

<Sleep (Low Power)> The HT command is used to set/read the time of inactivity (no serial or RF data is sent or received) before a wake-up initializer is sent by a TX (transmitting) RF modem. The HT parameter should be set shorter than inactivity timeout [ST Command] time of any RX (receiving) modems operating in Cyclic Sleep (SM=4-8). The wake-up initializer sent by the TX modem instructs all RX modems to remain awake to receive RF data.

From the RX modem perspective: After HT time elapses and the inactivity timeout [ST Command] is met, the RX modem goes into cyclic sleep. In cyclic sleep, the RX modem wakes once per sleep interval [SM Command] to check for a wake-up initializer. When a wake-up initializer is detected, the modem stays awake to receive data. The wake-up initializer must be longer than the cyclic sleep interval to ensure that sleeping modems detect incoming data.

When HT time elapses, the TX modem knows it needs to send a wake-up Initializer for all RX modems to remain awake and receive the next transmission.

AT Command: ATHT
Binary Command: 0x03 (3 decimal)
Parameter Range: 0 - 0xFFFF [x 100 milliseconds]
Default Parameter Value: 0xFFFF (wake-up initializer will not be sent)
Number of bytes returned: 2
Related Commands: LH (Wake-up Initializer Timer), SM (Sleep Mode), ST (Time before Sleep)

HV (Hardware Version) Command

<Diagnostics> The HV command is used to read the hardware version of the RF modem.

AT Command: ATHV
Parameter Range: 0 - 0xFFFF [Read-only]
Legacy Modem Minimum Firmware Version Required: v1.x80

ID (Modem VID) Command

<Networking and Security> The ID command is used to set/read the VID (Vendor Identification Number) of the RF modem. RF modems must have matching VIDs in order to communicate.

AT Command: ATID
Binary Command: 0x27 (39 decimal)
Parameter Range: 0x11 - 0x7FFF (user-settable) 0 - 0x10 and 0x8000 - 0xFFFF (factory-set)
Default Parameter Value: 0x3332 (13106d)
Number of bytes returned: 2

KY (AES Encryption Key) Command

<Networking and Security> The KY command is used to set the 256-bit AES (Advanced Encryption Standard) key for encrypting/decrypting data. Once set, the key cannot be read out of the modem by any means. The entire payload of the packet is encrypted using the key and the CRC is computed across the ciphertext. When encryption is enabled, each packet carries an additional 16 bytes to convey the random CBC Initialization Vector (IV) to the receiver(s). The KY value may be "0" or any 256-bit value (= 64 hex digits = 32 bytes). Any other value, including entering ATKY by itself with no parameters, causes an error.

A modem with the wrong key (or no key) will receive encrypted data, but the data driven out the serial port will be meaningless. Likewise, a modem with a key will receive unencrypted data sent from a modem without a key, but the output will be meaningless. Because CBC mode is utilized, repetitive data appears differently in different transmissions due to the randomly-generated IV.

AT Command: ATKY
Binary Command: 0x3C (60 decimal)
Parameter Range: 0 - (any other 64-digit hex valid key)
Default Parameter Value: 0 (disabled)
Number of bytes returned: 2
Number Base: Always Hexadecimal

LH (Wake-up Initializer Timer) Command

<Sleep (Low Power)> The LH Command is used to set/read the duration of time during which the wake-up initializer is sent. When receiving modems are in Cyclic Sleep Mode, they power-down after a period of inactivity (as specified by the ST parameter) and will periodically wake and listen for transmitted data. In order for the receiving modems to remain awake, they must detect ~35ms of the wake-up initializer.

LH Command must be used whenever a receiving modem is operating in Cyclic Sleep Mode. The Wake-up Initializer Time must be longer than the cyclic sleep time that [as determined by SM (Sleep Mode) parameter]. If the wake-up initializer time were less than the Cyclic Sleep interval, the connection would be at risk of missing the wake-up initializer transmission.

Refer to figures located under the SM command description to view diagrams of correct and incorrect configurations. The images emphasize that the LH value must be greater than the SM value.

AT Command: ATLH
Binary Command: 0x0C (12 decimal)
Parameter Range: 0 - 0xFF [x 100 milliseconds]
Default Parameter Value: 1
Number of bytes returned: 1
Related Commands: HT (Time before Wake-up Initializer), SM (Sleep Mode), ST (Time before Sleep)

MD (RF Mode) Command

<Networking and Security> The MD command is used to select/read the settings that enable the Polling and Repeater Modes on the modem.

Polling Mode - A 'Polling Base' is responsible for polling remotes. A 'Polling Remote' requires a poll in order to transmit.

Repeater Mode - A 'Repeater' re-sends RF data unless the transmission is addressed to it or if the transmission has already been detected. A 'Repeater End Node' handles repeated messages, but will not repeat the message over-the-air.

Refer to the Polling and Repeater Mode sections of the 'RF Communication Modes' chapter for more information.

AT Command: ATMD		
Binary Command: 0x31 (49 decimal)		
Parameter Range: 0 - 6		
	Parameter	Configuration
	0	Transparent Operation (Repeater Base)
	1	[reserved - not used]
	2	[reserved - not used]
	3	Polling Base
	4	Polling Remote
	5	Repeater
	6	Repeater End Node
Default Parameter Value: 0		
Number of bytes returned: 1		
Legacy Modem Minimum Firmware Version Required: 2.x20		

MK (Address Mask) Command

<Networking and Security> The MK command is used to set/read the Address Mask of a modem.

All RF data packets contain the Destination Address of the TX (transmitting) modem. When a packet is received, the TX modem Destination Address is logically "ANDed" (bitwise) with the Address Mask of the RX (receiving) modem. The resulting value must match the Destination Address or Address Mask of the RX modem for the packet to be received and sent out the RX modem's DO (Data Out) pin. If the "ANDed" value does not match the Destination Address or Address Mask of the RX modem, the packet is discarded.

Sniffer Mode (when MK = 0): ACK requests are ignored and every RX (receive) frame is sent to the UART, without regard for repeated frames.

All "0" values are treated as irrelevant values and ignored.

AT Command: ATMK
Binary Command: 0x12 (18 decimal)
Parameter Range: 0 - 0xFFFF
Default Parameter Value: 0xFFFF (65535d)
Number of bytes returned: 2
Related Commands: DT (Destination Address), HP (Hopping Channel), ID (Modem VID), MY (Source Address)

MT (Multi-transmit) Command

<Networking and Security> The MT command is used to enabled multiple transmissions of RF data packets. When Multi-transmit Mode is enabled (MT > 0), packets do not request an ACK (acknowledgment) from the receiving RF modem(s). MT takes precedence over RR, so if both MT and RR are non-zero, then MT+1 packets will be sent (with no ACK requests).

When a receiving modem receives a packet with remaining forced retransmissions, it calculates the length of the packet and inhibits transmission for the amount of time required for all retransmissions. Thereafter, a random number of delay slots are inserted between 0 and RN before transmission is allowed from the receiving modem(s). This prevents all listening modems from transmitting at once upon conclusion of a multiple transmission event (when RN > 0).

NOTE: The actual number of forced transmissions is the parameter value plus one. For example, if MT = 1, two transmissions of each packet will be sent.

AT Command: ATMT
Binary Command: 0x3D (61 decimal)
Parameter Range: 0 - 0xFF
Default Parameter Value: 0 (no forced retransmissions)
Number of bytes returned: 1
Related Commands: Networking (DT, MK, MY, RN, TT), Serial Interfacing (BR, PK, RB, RO), RF Interfacing (FS)

MY (Source Address) Command

<Networking and Security> The MY command is used to set/read the Source Address of the RF modem.

AT Command: ATMY
Binary Command: 0x2A (42 decimal)
Parameter Range: 0 - 0xFFFF
Default Parameter Value: 0xFFFF (Disabled - DT (Destination Address) parameter serves as both source and destination address.)
Number of bytes returned: 2
Related Commands: DT (Destination Address), HP (Hopping Channel), ID (Modem VID), MK (Address Mask)

NB (Parity) Command

<Serial Interfacing> The NB command is used to select/read the parity settings of the RF modem for UART communications.

AT Command: ATNB		
Binary Command: 0x23 (35 decimal)		
Parameter Range: 0 - 4		
	Parameter	Configuration
	0	8-bit (no parity or 7-bit (any parity)
	1	8-bit even
	2	8-bit odd
	3	8-bit mark
	4	8-bit space
Default Parameter Value: 0		
Number of bytes returned: 1		

PB (Polling Begin Address) Command

<Networking and Security> PB command is used to set/read the modem's Polling Begin Address - the first address polled Polling Mode is enabled.

Polling Operations: The 'Polling Base' (MD = 3) cycles through a sequential range of addresses, polling each 'Polling Remote' (MD = 4). The base then waits for a response and proceeds to the next 'Polling Remote'. Each 'Polling Remote' responds by sending the data from the Data In buffer following the RB and RO parameters. When there is no eligible data to send, the 'Polling Remote' will not respond. The 'Polling Base' will move to the next address in the polling sequence after a short delay.

AT Command: ATPB
Binary Command: 0x45 (69 decimal)
Parameter Range: 0 - 0xFFFF
Default Parameter Value: 0
Number of bytes returned: 2
Legacy Modem Minimum Firmware Version Required: 2.x20
Related Commands: MD (RF Mode), PE (Polling End Address), PD (Minimum Polling Delay)

PD (Minimum Polling Delay) Command

<Networking and Security> The PD command is used to set/read Polling Delay (Base, MD=3) or Polling Timeout (Remote, MD=4).

Polling Delay (Base) is the time between polling cycles. The Polling Base will start the polling cycle after sending the first poll. After the polling cycle has completed, the timer is restarted.

Polling Timeout (Remote) is the amount of time the remote unit will hold data from the serial port before discarding it. Data entered within the PD time of the poll is transmitted and not discarded.

AT Command: ATPD
Binary Command: 0x47 (71 decimal)
Parameter Range: 0 - 0xFFFF (Base: [x 1ms], Remote: [x 10ms])
Default Parameter Value: 0
Number of bytes returned: 2
Legacy Modem Minimum Firmware Version Required: 2.x20
Related Commands: MD (RF Mode), PB (Polling Begin Address), PE (Polling End Address)

PE (Polling End Address) Command

<Networking and Security> PE command is used to set/read the modem's Polling End Address - the last address polled when Polling Mode is enabled.

Polling Operations: The 'Polling Base' (MD = 3) cycles through a sequential range of addresses, polling each 'Polling Remote' (MD = 4). The base then waits for a response and proceeds to the next 'Polling Remote'. Each 'Polling Remote' responds by sending data from the DI buffer following the RB and RO parameters. When there is no eligible data to send, the 'Polling Remote' will not respond. The 'Polling Base' will move to the next address in the polling sequence after a short delay.

AT Command: ATPE
Binary Command: 0x46 (70 decimal)
Parameter Range: 0 - 0xFFFF

AT Command: ATPE
Default Parameter Value: 0
Number of bytes returned: 2
Legacy Modem Minimum Firmware Version Required: 2.x20
Related Commands: MD (RF Mode), PB (Polling Begin Address), PD (Minimum Polling Delay)

PK (Maximum RF Packet Size) Command

<RF Interfacing> The PK command is used to set/read the maximum size of RF packets transmitted from an RF modem. The maximum packet size can be used along with the RB and RO parameters to implicitly set the channel dwell time.

If PK is set above 256 and BR is subsequently changed to 0, PK will automatically be lowered to 256 and a warning will be raised (refer to the BR (RF Data Rate) and WN (Warning Data) commands for details).

Changes to the PK parameter may have a secondary effect on the RB (Packetization Threshold) parameter. RB must always be less than or equal to PK. If PK is changed to a value that is less than the current value of RB, the RB value is automatically lowered to be equal to PK.

* When BR = 0 (9600 baud), the maximum PK value is 0x100 (256d). When BR = 1 (115,200 baud), the maximum PK value is 0x800 (2048d).

AT Command: ATPK
Binary Command: 0x29 (41 decimal)
Parameter Range: 1 - 0x800 [Bytes]
Default Parameter Value: 0x100* or 0x800* (256 or 2048 decimal)
Number of bytes returned: 2
Related Commands: BR (RF Data Rate) RB (Packetization Threshold), RO (Packetization Timeout), WN (Warning Data)

PL (TX Power Level) Command

<RF Interfacing> The PL command is used to set/read the power level at which the RF modem transmits data. The XTend vB modem does not support the 1 mW and 10 mW power levels. If PL is set to 0 or 1, the device will transmit at 100 mW.

AT Command: ATPL
Binary Command: 0x3A (58 decimal)
Parameter Range: 0 - 4
Default Parameter Value: 4
Number of bytes returned: 1

Setting	XBee Tx power level	XBee-PRO Tx Power level
0	1 mW	100 mW
1	10 mW	100 mW
2	100 mW	100 mW
3	500 mW	500 mW
4	1000 mW (1 Watt)	1000 mW (1 Watt)

PW (Pin Wake-up) Command

<Sleep (Low Power)> Under normal operation, an RF modem in Cyclic Sleep Mode cycles from an active state to a low-power state at regular intervals until data is ready to be received. If the PW parameter is set to 1, the GPI2 pin (SLEEP) can be used to awaken the modem from Cyclic Sleep. When the GPI2 Pin is de-asserted (low), the modem will be fully operational and will not go into Cyclic Sleep.

Once the GPI2 pin is asserted, the modem will remain active for the period of time specified by the ST (Time before Sleep) parameter and will return to Cyclic Sleep Mode (if no data is ready to be transmitted). PW Command is only valid if Cyclic Sleep has been enabled.

AT Command: ATPW		
Binary Command: 0x1D (29 decimal)		
Parameter Range: 0 - 1		
	Parameter	Configuration
	0	Disabled
	1	Enabled
Default Parameter Value: 0		
Number of bytes returned: 1		
Related Commands: SM (Sleep Mode), ST (Time before Sleep)		

RB (Packetization Threshold) Command

<Serial Interfacing> The RB command is used to set/read the character threshold value.

RF transmission begins after data is received in the DI Buffer and either of the following criteria is met:

- RB characters received by the UART
- RO character times of silence detected on the UART receive lines (after receiving at least 1 Byte of data)

If PK (Max. RF Packet Size) is lowered below the value of RB, RB is automatically lowered to match the PK value. If (RO = 0), RB bytes must be received before beginning transmission.

Note: RB and RO criteria only apply to the first packet of a multi-packet transmission. If data remains in the DI Buffer after the first packet, transmissions will continue in a streaming manner until there is no data left in the DI Buffer (UART receive buffer).

AT Command: ATRB
Binary Command: 0x20 (32 decimal)
Parameter Range: 0 - PK parameter value (up to 0x800 Bytes)
Default Parameter Value: 0x800 Bytes
Number of bytes returned: 2
Related Commands: BR (RF Data Rate), PK (RF Packet Size), RO (Packetization Timeout)

RC (Ambient Power - Single Channel) Command

<Diagnostics> The RC command is used to examine and report the power level on a given channel.

Sample output:

```
-78 dBm [when CF = 0]
4e      [when CF = 1]
-78     [when CF = 2]
```

AT Command: ATRC
Parameter Range (read-only): 0 - 0x31 [dBm]
Number of bytes returned: 1
Related Commands: RM (Ambient Power - All Channels)

RE (Restore Defaults) Command

<Diagnostics> The RE command is used to restore all configurable parameters to their factory default settings.

The RE Command does not cause default values to be stored to non-volatile (persistent) memory. For the restored default settings to persist in the modem's non-volatile memory and be saved in the event of RF modem reset or power-down, the WR (Write) command must be issued prior to power-down or reset.

AT Command: ATRE
Binary Command: 0x0E (14 decimal)

RM (Ambient Power - All Channels) Command

<Diagnostics> The RM command is used to examine and report power levels on all channels. If no parameter is given, the channels are scanned one time. If a parameter is given, the channels are repeatedly scanned for that number of seconds. The maximum power level seen for each channel is reported (i.e. peak hold).

A graphical spectrum analyzer can be implemented by repeatedly sending the RM command (with no arguments) and reading the resultant 50 power levels (this is easiest to do when CF = 1 or 2).

```
Sample output [when CF = 0]:      Ch 0: -100 dBm
                                   Ch 1: -103 dBm
                                   ...
                                   Ch 49: -99 dBm
Sample output [when CF = 1]:      64
```

67
 ...
 63
 Sample output [when CF = 2]: 100
 -103
 ...
 -99

AT Command: ATRM
Parameter Range: no parameter - 0x7D0)
Number of bytes returned: 2
Related Commands: RC (Ambient Power - Single channel)

RN (Delay Slots) Command

<Networking and Security> The RN command is used to set/read the time delay that the transmitting RF modem inserts before attempting to resend a packet. If the transmitting modem fails to receive an acknowledgment after sending a packet, it inserts a random number of delay slots (ranging from 0 to (RN minus 1)) before attempting to resend the packet. Each delay slot is 5 msec (when BR=1) and 54 msec (when BR=0).

If two modems attempt to transmit at the same time, the random time delay after packet failure allows only one modem to transmit the packet successfully; while the other modem waits until the channel available for RF transmission.

RN Command is only applicable if retries have been enabled [RR (Retries) Command] or if forced delays will be inserted into a transmission [TT (Streaming Limit) Command].

AT Command: ATRN
Binary Command: 0x19 (25 decimal)
Parameter Range: 0 - 0xFF [38 ms slots]
Default Parameter Value: 0 (no delay slots inserted)
Number of bytes returned: 1
Related Commands: RR (Retries), TT (Streaming Limit)

RO (Packetization Timeout) Command

<Serial Interfacing> The RO command is used to set/read the Packetization Timeout setting. RF transmission begins when data is in the DI buffer and either of the following criteria are met:

- RO character times of silence on the UART receive lines (after receiving at least 1 byte)
- RB characters have been received by the UART

RB and RO criteria only apply to the first packet of a multi-packet transmission. If data remains in the DI Buffer (UART receive) after the first packet, transmissions will continue in a streaming manner until there is no data left in the DI Buffer.

When RO is the transmission-beginning criteria: The actual time between the reception of the last character from the UART and the beginning of RF transmission will be at least 800 µsec longer than the actual RO time to allow for

transmission setup. Additionally, it is subject to 100-200 μ sec of additional uncertainty, which could be significant for small values of RO at high UART bit rates.

The correct UART character time (10, 11, or 12 bits) is calculated based on the following criteria:

- 1 start bit
- 8 data bits
- 0 or 1 parity bit [as determined by the NB (Parity) Command]
- 1 or 2 stop bits [as determined by SB (Stop Bits) Command]

AT Command: ATRO
Binary Command: 0x21 (33 decimal)
Parameter Range: 0 - 0xFFFF [x UART character times]
Default Parameter Value: 3
Number of bytes returned: 2
Related Commands: RB (Packetization Threshold)

RP (RSSI PWM Timer) Command

<Diagnostics> RP Command is used to enable a PWM ("Pulse Width Modulation") output on the Config/RSSI pin (pin 11 of the OEM RF Module). The pin is calibrated to show the difference between received signal strength and the sensitivity level of the RF modem. PWM pulses vary from zero to 95 percent. Zero percent means the received RF signal is at or below the published sensitivity level of the modem.

AT Command: ATRP
Binary Command: 0x22 (34 decimal)
Parameter Range: 0 - 0xFF [x 100 milliseconds]
Default Parameter Value: 0x20 (32d)
Number of bytes returned: 1

The following table shows dB levels above sensitivity and PWM values (The total time period of the PWM output is 8.32 ms. PWM output consists of 40 steps and therefore the minimum step size is 0.208 ms.):

dBm above sensitivity	PWM percentage (high period / total period)
10	20%
20	35%
30	50%

A non-zero value defines the time that PWM output is active with the RSSI value of the last received RF packet. After the set time when no RF packets are received, PWM output is set low (0 percent PWM) until another RF packet is received. PWM output is also set low at power-up. A parameter value of 0xFF permanently enables PWM output and always reflects the value of the last received RF packet.

The Config/RSSI pin is shared between PWM output and Config input. When the modem is powered, the Config pin is an input. During the power-up sequence, if RP parameter is a non-zero value, the Config pin is configured as an output

and set low until the first RF packet is received. With a non-zero RP parameter, the Config pin is an input for RP ms after power up.

RR (Retries) Command

<Networking and Security> The RR command is used to set/read the maximum number of retries sent for a given RF packet. When RR Command is enabled (RR>0), RF packet retries and ACKs (acknowledgments) are enabled.

Exceptions: If the MT command is enabled (MT>0) or if a broadcast Destination Address is used (DT = 0xFFFF); RF packet retries and ACKs are disabled.

After transmitting a packet, the transmitting RF modem waits to receive an acknowledgment from a receiving modem. If the acknowledgment is not received in the period of time specified by RN (Delay Slots) Command, the original packet is transmitted again. The RF packet is transmitted repeatedly until an acknowledgment is received or until the packet is sent RR times.

AT Command: ATRR
Binary Command: 0x18 (24 decimal)
Parameter Range: 0 - 0xFF
Default Parameter Value: 0x0A (10 decimal)
Number of bytes returned: 1

RT (GPI1 Configuration) Command

<Serial Interfacing> The RT command is used to set/read the behavior of the GPI1 pin (GPI1) of the OEM RF Module. The pin can be configured to enable binary programming or $\overline{\text{RTS}}$ flow control.

AT Command: ATRT		
Binary Command: 0x16 (22 decimal)		
Parameter Range: 0 - 2		
	Parameter	Configuration
	0	Disabled
	1	Enable Binary Programming
	2	Enable $\overline{\text{RTS}}$ Flow Control
Default Parameter Value: 0		
Number of bytes returned: 1		
Related Commands: SM (Sleep Mode), ST (Time before Sleep)		

SB (Stop Bits) Command

<Serial Interfacing> The SB Command is used to set/read the number of stop bits in the data packet.

AT Command: ATSB		
Binary Command: 0x37 (55 decimal)		
Parameter Range: 0 - 1		
	Parameter	Configuration
	0	1 stop bit
	1	2 stop bits
Default Parameter Value: 0		
Number of bytes returned: 1		

SH (Serial Number High) Command

<Diagnostics> SH Command is used to set/read the serial number high word of the RF modem.

AT Command: ATSH	
Binary Command: 0x25 (37 decimal)	
Parameter Range (read-only): 0 - 0xFFFF	
Default Parameter Value: varies	
Number of bytes returned: 2	
Related Commands: SL (Serial Number Low)	

SL (Serial Number Low) Command

<Diagnostics> SL Command is used to set/read the serial number low word of the RF modem.

AT Command: ATSL	
Binary Command: 0x26 (38 decimal)	
Parameter Range (read-only): 0 - 0xFFFF	
Default Parameter Value: varies	
Number of bytes returned: 2	
Related Commands: SH (Serial Number High)	

SM (Sleep Mode) Command

<Sleep Mode (Low Power)> The SM Command is used to set/read the RF modem's Sleep Mode settings that configure the modem to run in states that require minimal power consumption.

AT Command: ATSM		
Binary Command: 0x01		
Parameter Range: 0 - 8 (3 is reserved)		
	Parameter	Configuration
	0	Disabled
	1	Pin Sleep
	2	Serial Port Sleep
	3	[reserved]
	4	Cyclic 1.0 second sleep (RF modem wakes every 1.0 seconds)
	5	Cyclic 2.0 second sleep
	6	Cyclic 4.0 second sleep
	7	Cyclic 8.0 second sleep
	8	Cyclic 16.0 second sleep
Default Parameter Value: 0		
Number of bytes returned: 1		
Related Commands:		
Pin Sleep - PC (Power-up Mode), PW (Pin Wake-up)		
Serial Port Sleep - ST (Time before Sleep)		
Cyclic Sleep - ST (Time before Sleep), LH (Wake-up Initializer Timer), HT (Time Before Wake-up Initializer), PW (Pin Wake-up)		

ST (Time before Sleep) Command

<Sleep Mode (Low Power)> The ST Command is used to set/read the period of time (in milliseconds) in which the RF modem remains inactive before entering Sleep Mode.

For example, if the ST Parameter is set to 0x64 (100 decimal), the modem will enter into Sleep mode after 10 seconds of inactivity (no transmitting or receiving).

This command can only be used if Cyclic Sleep or Serial Port Sleep Mode settings have been selected using SM (Sleep Mode) Command.

AT Command: ATST
Binary Command: 0x02 (2 decimal)
Parameter Range:(ATAT+3) - 0x7FFF [x 100 milliseconds]
Default Parameter Value: 0x64 (100 decimal)

AT Command: ATST

Number of bytes returned: 2

Related Commands: SM (Sleep Mode), LH (Wake-up Initializer Timer), HT (Time before Wake-up Initializer)

TP (Board Temperature) Command

<Diagnostics> TP Command is used to read the current temperature of the board.

AT Command: ATTP

Binary Command: 0x38 (56 decimal)

Parameter Range (read-only): 0- 0x7F

Number of bytes returned: 1

Related Command: WN (Warning Data)

Sample Output:

26 C [when ATCF = 0]
 1A [when ATCF = 1]
 26 [when ATCF = 2].

TR (Transmit Error Count) command

<Diagnostics> The TR command is used to report the number of retransmit failures. This number is incremented each time a packet is not acknowledged within the number of retransmits specified by the RR (Retries) parameter. The number of packets therefore are counted that were not successfully received and subsequently discarded.

The TR parameter is not non-volatile and is reset to zero when the RF modem is reset.

AT Command: ATTR

Binary Command: 0x1B (27 decimal)

Parameter Range: 0 - 0xFFFF

Default Parameter Value: 0

Number of bytes returned: 2

Related Commands: RR (Retries)

TT (Streaming Limit) command

<Networking and Security> The TT command is used to set/read the limit on the number of bytes that can be sent out before a random delay is issued.

If an RF modem is sending a continuous stream of RF data, a delay is inserted which stops its transmission and allows other modems time to transmit (once it sends TT bytes of data). Inserted random delay lasts between 1 and 'RN + 1' delay slots, where each delay slot lasts 38 ms.

The TT command can be used to simulate full-duplex behavior.

AT Command: ATTT
Binary Command: 0x1A (26 decimal)
Parameter Range: 0 - 0xFFFF
Default Parameter Value: 0 (disabled)
Number of bytes returned: 2
Related Commands: RN (Delay Slots)

TX (Transmit Only) command

<RF Interfacing> The TX command is used to set/read the transmit/receive behaviors of the RF modem. Setting a modem to TX-only (TX = 1) may reduce latency because the transmitting modem will never be confined to receiving data from other modems.

AT Command: ATTX						
Binary Command: 0x3F (63 decimal)						
Parameter Range: 0 - 1						
<table border="1"> <thead> <tr> <th>Parameter</th> <th>Configuration</th> </tr> </thead> <tbody> <tr> <td>0</td> <td>TX and RX</td> </tr> <tr> <td>1</td> <td>TX-only</td> </tr> </tbody> </table>	Parameter	Configuration	0	TX and RX	1	TX-only
Parameter	Configuration					
0	TX and RX					
1	TX-only					
Default Parameter Value: 0						
Number of bytes returned: 1						

VL (Firmware Version - Verbose)

<Diagnostics> The VL command is used to read the verbose firmware version of the RF modem.

AT Command: ATVL
Parameter Range: returns string
Default Parameter Value: 0
Number of bytes returned: 2

VR (Firmware Version - Short) Command

<Diagnostics> The VR command is used to read the firmware version of the RF modem.

Note: Firmware versions contain four significant digits - "A.B.C.D". If B=2, the modem is programmed for operation in Australia only.

AT Command: ATVR
Binary Command: 0x14 (20 decimal)
Parameter Range (read-only): 0 - 0xFFFF
Number of bytes returned: 2

WA (Active Warning Numbers) command

<Diagnostics> The WA command reports the warning numbers of all active warnings - one warning number per line. No further information is shown and warning counts are not reset.

AT Command: ATWA
Parameter Range:Returns string - one warning number per line.

Sample Output (indicates warnings 1 and 3 are currently active):

```
1
3
OK
```

WN (Warning Data) command

<Diagnostics> WN command is used to report the following data for all active and sticky warnings:

- Warning number and description
- Number of occurrences since the last WN or WS command
- Whether the warning is currently active

Warnings, which are not currently active and have not been active since the last issuance of the WN or WS commands, are not displayed. The WN command also resets all non-zero warning counts; except for warnings that are presently active, which are set to 1.

AT Command: ATWN
Parameter Range: returns string

Sample output:

Warning 4: Over-temperature 5 occurrences; presently inactive.

Warning #	Description
1	Under-voltage. This is caused if the supply voltage falls below the minimum threshold for the lowest power level (2.8 V). If/when the voltage rises above the threshold, the warning is deactivated. The module will not transmit below this voltage threshold.
2	Over-voltage. This is caused if the supply voltage exceeds 5.75 V. Transmission is not allowed while this warning is active.
3	Under-temperature. This is caused if the temperature sensed by the module is less than -40 C. The module does not artificially limit operation while this warning is active, but module functionality is not guaranteed.

Warning #	Description
4	Over-temperature. This is caused if the temperature sensed by the module is greater than 105 C. The module does not allow transmission nor reception while this warning is active. The warning is deactivated when the temperature falls to 100 C.
5	Power reduced. This is caused if the transmit power has to be reduced from the level programmed by PL Command due to insufficient supply voltage.
6	Default calibration data in flash. This is caused if the module-specific power calibration data is either not present or is invalid, or if none of the parameters have been modified from their default values. Power levels may be incorrect.
7	Default configuration parameters in flash. This is caused if user-modifiable parameters (i.e. those stored by a 'WR' command) in flash are all the compiled-in default values. This is caused if the user configuration is found to be not present or invalid at power-up and there is no custom configuration, or if no user-modifiable parameters have been modified from the compiled-in defaults. Modification of one or more parameters without the subsequent WR to commit the changes to flash will not deactivate this warning, since it reflects the status of the parameters in flash. Note that this warning does not reflect usage of the custom configuration defaults, only usage of the compiled-in defaults.
8	Default factory configuration parameters in flash. This is caused if the factory parameters in flash are all the default values. This is caused if the factory configuration is found to be not present or invalid at power-up, or if no factory parameters have been modified.

WR (Write) command

<(Special)> The WR command is used to write configurable parameters to non-volatile memory (Values remain in the modem's memory until overwritten by another use of WR Command).

If changes are made without writing them to non-volatile memory, the modem will revert back to previously saved parameters the next time the modem is powered-on.

If the non-volatile user configuration is not correct, WR will re-attempt (up to 3x). If all three attempts fail, the command will return an ERROR alert.

AT Command: ATWR

Binary Command: 0x08

WS (Sticky Warning Numbers) command

<Diagnostics> The WS command reports warning numbers of all warnings active since the last use of the WS or WN command (including any warnings which are currently active). This command also resets all non-zero warning counts, except for warnings that are presently active, which are set to 1.

AT Command: ATWS

Parameter Range (read-only): 1 - 8

Number of bytes returned: 1

API operation

By default, XTend RF Modems act as a serial line replacement (Transparent Operation) - all UART data received through the DI pin is queued up for RF transmission. When the modem receives an RF packet, the data is sent out the DO pin with no additional information.

Inherent to Transparent Operation are the following behaviors:

- If modem parameter registers are to be set or queried, a special operation is required for transitioning the modem into Command Mode; see [Command mode](#) on page 19.
- In point-to-multipoint systems, the application must send extra information so that the receiving modem(s) can distinguish between data coming from different remotes.

As an alternative to the default Transparent Operation, API (Application Programming Interface) Operations are available. API operation requires that communication with the modem be done through a structured interface (data is communicated in frames in a defined order). The API specifies how commands, command responses and modem status messages are sent and received from the modem using a UART Data Frame.

API frame specifications

Two API modes are supported and both can be enabled using the AP (API Enable) command. Use the following AP parameter values to configure the modem to operate in a particular mode:

- AP = 0 (default): Transparent Operation (UART Serial line replacement)
API modes are disabled.
- AP = 1: API Operation
- AP = 2: API Operation (with escaped characters)

Any data received prior to the start delimiter is silently discarded. If the frame is not received correctly or if the checksum fails, the data is silently discarded.

API Operation (AP parameter = 1)

When this API mode is enabled (AP = 1), the UART data frame structure is defined as follows:



MSB = Most Significant Byte, LSB = Least Significant Byte

API Operation - with Escape Characters (AP parameter = 2)

When this API mode is enabled (AP = 2), the UART data frame structure is defined as follows:

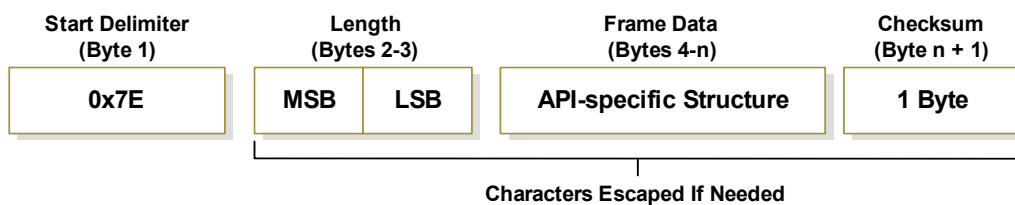

MSB = Most Significant Byte, LSB = Least Significant Byte

Escape characters

When sending or receiving a UART data frame, specific data values must be escaped (flagged) so they do not interfere with the UART or UART data frame operation. To escape an interfering data byte, insert 0x7D and follow it with the byte to be escaped XOR'd with 0x20.

Data bytes that need to be escaped:

- 0x7E – Frame Delimiter
- 0x7D – Escape
- 0x11 – XON
- 0x13 – XOFF

Example - Raw UART Data Frame (before escaping interfering bytes):

0x7E 0x00 0x02 0x23 0x11 0xCB

0x11 needs to be escaped which results in the following frame:

0x7E 0x00 0x02 0x23 0x7D 0x31 0xCB

Note In the above example, the length of the raw data (excluding the checksum) is 0x0002 and the checksum of the non-escaped data (excluding frame delimiter and length) is calculated as:
 $0xFF - (0x23 + 0x11) = (0xFF - 0x34) = 0xCB$.

Checksum

To test data integrity, a checksum is calculated and verified on non-escaped data.

To calculate: Not including frame delimiters and length, add all bytes keeping only the lowest 8 bits of the result and subtract from 0xFF.

To verify: Add all bytes (include checksum, but not the delimiter and length). If the checksum is correct, the sum will equal 0xFF.

API Types

Frame data of the UART data frame forms an API-specific structure as follows:

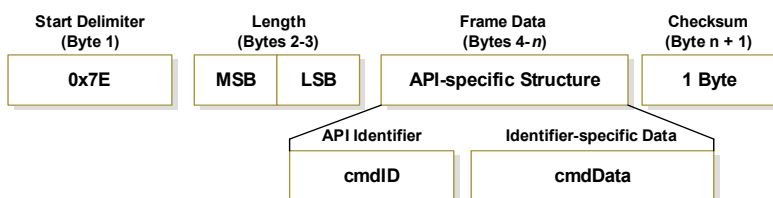

The cmdID frame (API-identifier) indicates which API messages will be contained in the cmdData frame (Identifier-specific data). Refer to the sections that follow for more information regarding the supported API types. Note that multi-byte values are sent big endian.

RF Modem Status

API Identifier: 0x8A

RF modem status messages are sent from the modem in response to specific conditions.

RF Modem Status Frames

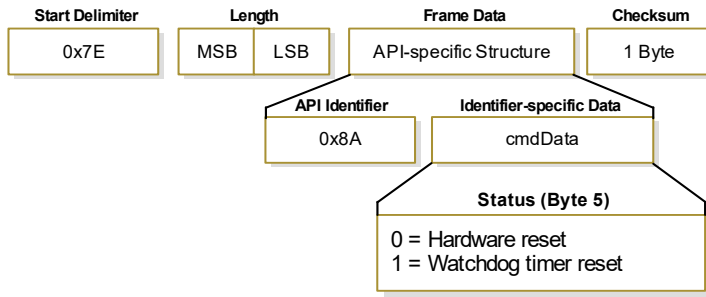

TX (Transmit) Request: 16-bit address

API Identifier Value: 0x01

A TX Request message will cause the modem to send RF Data as an RF Packet.

TX Packet (16-bit address) Frames

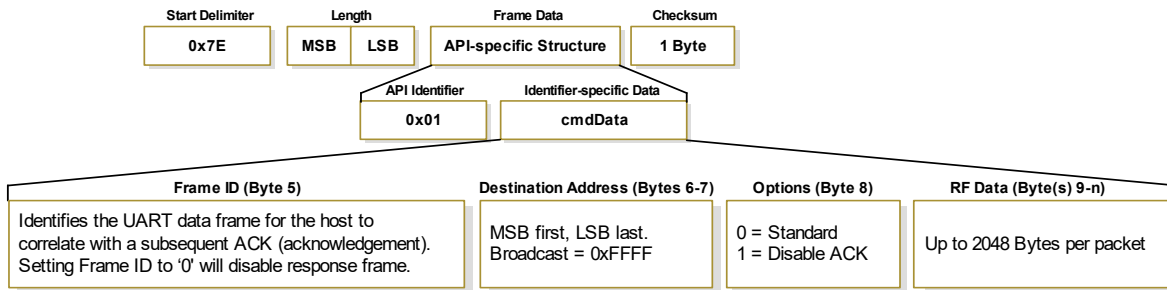

Example: TX Packet API Frames

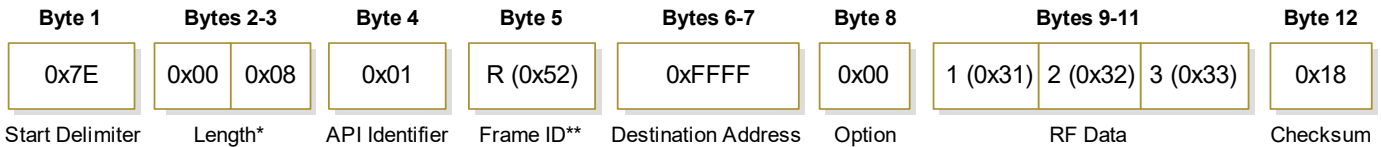

* Length [Bytes] = API Identifier + Frame ID + Option + RF Data

** "R" value was arbitrarily selected

TX (Transmit) Status

API Identifier Value: 0x89

When a TX Request is completed, the modem sends a TX Status message. This message will indicate if the packet was transmitted successfully or if there was a failure.

TX Status Frames

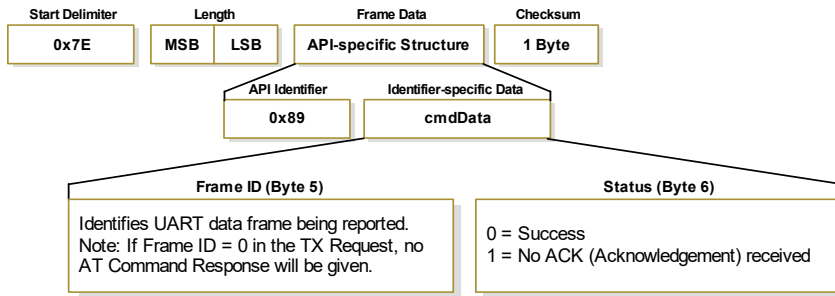

Note “STATUS = 1” occurs when all retries are expired and no ACK is received.
 “STATUS = 3” occurs when a packet is purged due to a ‘Polled Remote’ not receiving a poll.

RX (Receive) Packet: 16-bit address

API Identifier Value: 0x81

When the modem receives an RF packet, it is sent out the UART using this message type.

RX Packet (16-bit address) Frames

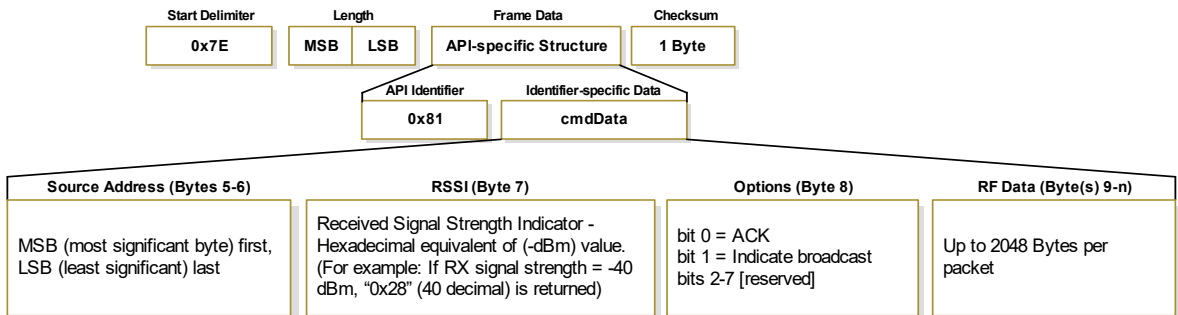

RF communication modes

Network topologies

The XTend RF Module supports three different network topologies: point-to-point, point-to-multipoint and peer-to-peer.

Point-to-point networks

This following section provides the RF communication type and RF mode for XTend RF Module point-to-point networks.

Definition

Point-to-point means an RF data link between two devices.



Sample network profile (Broadcast communications)

Use the default values for all devices.

Sample network profile (Acknowledged communications)

Assume the default value for all parameters that are not in this list. These profiles do not reflect addressing implementations.

1. Use XCTU or another terminal program to send the AM command. See the AM command for details.
2. Set the destination address to 0xFFFF, send: **ATDT FFFF**

Basic RF modes

Streaming, Multi-Transmit, Repeater.

Acknowledged RF mode

Acknowledged mode.

Point-to-multipoint networks

This following section provides the RF communication type and RF mode for XTend RF Module point-to-multipoint networks.

Definition

Point-to-multipoint means a network with RF data links between one base and multiple remotes.

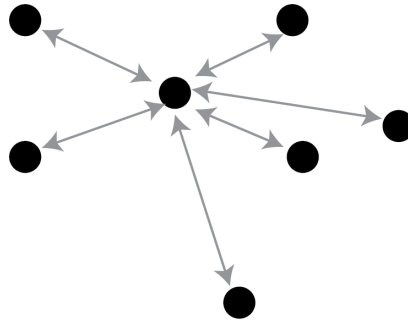

Sample network profile (Broadcast communications)

Assume the default value for all parameters that are not in this list. These profiles do not reflect addressing implementations.

Base:

1. Send **ATMY 0** to set the source address to 0x00.
2. Send **ATDT FFFF** to set the destination address to 0xFFFF.

Remotes:

1. Use XCTU or another terminal program to send the AM command. See the AM command for details.
2. Send **ATDT 0** to set the destination address to 0x00.

Sample network profile (Acknowledged communications)

Assume the default value for all parameters that are not in this list. These profiles do not reflect addressing implementations.

Base:

1. Send **ATMY 0** to set the source address to 0x00.
2. Send **ATDT FFFF** to set the destination address to 0xFFFF.
3. Send **ATRR 3** to set the number of retries to 3.

Remotes:

1. Use XCTU or another terminal program to send the AM command.
2. Send **ATDT FFFF** to set the destination address to 0xFFFF.

3. Send **ATRR 3** to set the number of retries to 3.

Basic RF modes

Streaming, Multi-Transmit, Repeater, and Polling.

Acknowledged RF mode

Acknowledged and Polling.

Peer to peer networks

This following section provides the RF communication type and RF mode for XTend RF Module peer-to-peer networks.

Definition

In Peer-to-peer networks, RF devices remain synchronized without the use of master/server dependencies. Each device shares the roles of master and slave. Digi's peer-to-peer architecture features fast synch times (35 ms to synchronize devices) and fast cold start times (50 ms before transmission).

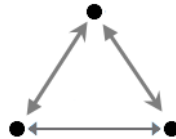

Sample network profile (Broadcast communications)

Assume the default value for all parameters that are not in this list. These profiles do not reflect addressing implementations.

Use the default values for all devices.

Sample network profile (Acknowledged communications)

Assume the default value for all parameters that are not in this list. These profiles do not reflect addressing implementations.

All devices:

1. Send **ATMY 0** to set the source address to 0x00.
2. Send **ATDT FFFF** to set the destination address to 0xFFFF.
3. Send **ATRR 3** to set the number of retries to 3.

Basic RF modes

Streaming.

Acknowledged RF mode

Acknowledged.

Addressing

Each RF packet contains addressing information that the receiving devices use to filter incoming RF data. Receiving devices inspect the Preamble ID (**HP** parameter), Vendor Identification Number (**ID** parameter) and Destination Address (**DT** parameter) in each RF packet. A receiving device discards all data that does not pass through all three network security layers.

The following image illustrates the addressing layers in the RF packet header.

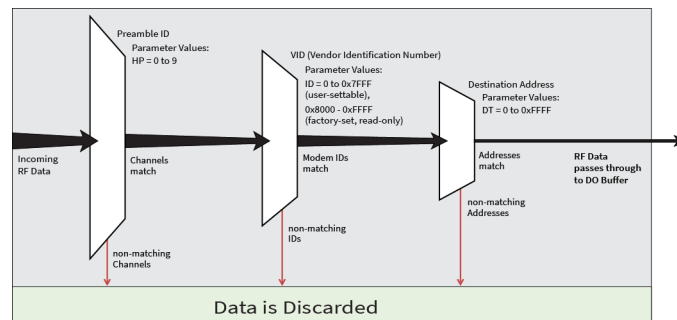

Address recognition

The transmitting device can address transmissions to a specific device or group of devices using the DT and MK commands. A receiving device only accepts a packet if it determines that the packet is addressed to it, either as a global or local packet. The receiving device makes this determination by inspecting the destination address of the packet and comparing it to its own address and address mask.

The transmitting device determines whether the packet is for a specific node (local address) or multiple nodes (global address) by comparing the packet's destination address (DT) and its own address mask (MK). This assumes you program the address masks on the transmitting device and receiving device to the same value for proper operation in each RF communication mode.

For more information, see the DT (Destination Address) and MK (Address Mask) commands.

Basic communications

Basic communications includes two sub-types:

- **Broadcast.** By default, the XTend RF Module communicates through Broadcast communications and within a peer-to-peer network topology. When any device transmits, all other devices within range receive the data and pass it directly to their host device.
- **Addressed.** If addressing parameters match, the device forwards the RF data it receives to the DOUT buffer; otherwise, it discards the RF data.

When using Basic communications, the integrator handles any functions, such as acknowledgments, at the application layer. The Broadcast modes provide transparent communications, meaning that the RF link replaces a wired link.

Streaming mode (default)

Streaming mode is most appropriate for data systems that are more sensitive to latency and/or jitter than to occasional packet loss; for example: streaming audio or video.

Characteristics	Highest data throughput Lowest latency and jitter Reduced immunity to interference Transmissions never acknowledged (ACK) by receiving device(s)
Required parameter values (TX device)	RR = 0
Related commands	Networking (DT, MK, MY), Serial interfacing (PK, RB, RO, TT)

Streaming mode connection sequence

Events and processes in this mode are common to all of the other RF modes.

When streaming data, the firmware only observes the RB and RO parameters on the first packet.

After transmission begins, the transmission event continues without interruption until the DIN buffer is empty or the device reaches the streaming limit (TT parameter). As with the first packet, the payload of each subsequent packet includes up to the maximum packet size (PK parameter).

The TX (transmitting) device specifies the TT parameter as the maximum number of bytes the TX device can send in one transmission event. After the device reaches the TT parameter threshold, the TX device forces a random delay of 1 to RN delay slots; exactly 1 delay slot if RN = 0.

The TX device sends subsequent packets without an RF initializer since RX (receiving) devices remain synchronized with the TX device for the duration of the transmission (from preceding packet information). However, due to interference, some RX devices may lose data (and synchronization to the TX device), particularly during long transmission events.

Once the TX device has sent all pending data or has reached the TT limit, the transmission event ends. The TX device does not transmit again for exactly RN delay slots if the local (for example the TX device's) RN parameter is set to a nonzero value. The RX device(s) do not transmit for a random number of delay slots between 0 and (RN-1) if the local (for example the RX device's) RN parameter is set to a non-zero value. These delays lessen congestion following long bursts of packets from a single TX device, during which several RX devices may have become ready to transmit.

Multi-transmit mode

Use Multi-transmit mode for applications that require reliable delivery without using retries and acknowledgments.

Characteristics	Reliable delivery through forcing the transmission of every RF packet. Every RF packet is sent exactly MT + 1 times, with no delays between packets. Diminished throughput and increased latency.
Required parameter values (TX device)	MT ≥ 1.
Related commands	Networking (DT, MK, MY, RN, TT), Serial interfacing (BR, PK, RB, RO), RF interfacing (FS).

Multi-transmit mode connection sequence

In Multi-transmit mode, the device re-transmits each packet MT times, for a total of (MT+1) transmissions. There is no delay between retransmissions, and the TX (transmitting) device never receives RF data between retransmissions. Each retransmission includes an RF initializer. A transmission event may include follow-on packets, each of which retransmit MT times. Devices ignore the Forced Sync (FS) parameter in Multi-Transmit Mode.

The firmware does not apply the RB and RO parameters to follow-on packets, meaning that once transmission has begun, it continues without interruption until the DIN buffer is empty or the device reaches the streaming limit (TT parameter). As with the first packet, the payload of each follow-on packet includes up to the maximum packet size (PK parameter) bytes, and the TX device checks for more pending data near the end of each packet. The device does not send follow-on packets until it finishes all retransmissions of the previous packet.

The TX device specifies the streaming limit (TT) as the maximum number of bytes that the TX device can send in one transmission event, which may consist of many packets. If the device reaches the TT parameter limit, the TX device forces a random delay of 1 to RN delay slots (exactly 1 delay slot if RN is zero). In Multi-transmit mode, the firmware counts each packet only once when tracking the streaming limit (TT), no matter how many times it is retransmitted.

When an RX (receiving) device receives a Multi-transmit packet, it calculates the amount of time remaining in the Multi-transmit event, and inhibits its own transmissions for the duration of the Multi-transmit event, plus a random number of delay slots between 0 and (RN-1). If the local RN parameter is zero, the delay is only for the calculated duration of the event. An RX device only needs to receive one of the transmissions, and it keep the channel off until the TX device is complete. If follow-on packets are coming, the RX devices move to the new frequency and listen for the follow-on packet for a specific period of time.

Repeater mode

Use Repeater mode in networks where you need intermediary devices to relay data to devices beyond the transmission range of the base device.

<p>Characteristics</p>	<p>Low power consumption.</p> <p>Minimizes interference</p> <p>Tags each RF packet with a unique Packet ID (PID).</p> <p>Each repeater only repeats a packet once (the PID tracks the packet).</p> <p>Increases latency and decreases throughput. The number of hops determine latency and throughput, not the number of repeaters. Multiple repeaters within range of a source node count as one hop.</p> <p>All RF packets propagate to every device in the network (filtering rules apply).</p> <p>Packet destination addresses (DT) determine which packets the device sends out the serial port and/or retransmits.</p> <p>Broadcast communications: each packet comes out every node exactly once.</p> <p>Addressed communications: all devices see every packet. Only the devices with a matching address forward it to the DOUT buffer.</p>
<p>Constraints</p>	<p>Requires that each device have a unique MY parameter.</p> <p>System must introduce only one packet at a time to the network for transmission. The PK parameter determines the maximum number of bytes.</p> <p>Each hop (H) decreases network throughput by a factor of $1/(H+1)$. Additional repeaters add network redundancy without decreasing throughput.</p>

Suggestions	<p>Insert a variable delay before repeating packets to avoid collisions (based on RSSI).</p> <p>Buffer any incoming serial data and delay response packet transmissions until the previous packet clears out of the network.</p> <p>For best results, use the RO and RB commands to ensure that the RF packets align with the underlying protocol packets as the network can only accept one RF packet at a time.</p>
Required parameter values (TX device)	<p>MD = 5 or 6.</p> <p>MY = unique value. You can accomplish this by issuing the AM and WR commands to all devices in the network.</p>
Related commands	Networking (MD, DT, MY, AM), Serial interfacing (RN, PK, RO, RB)

Repeater mode theory of operation

You can extend the effective range and reliability of your data system by forwarding traffic through one or more repeaters. Instead of using routing tables and path discovery to establish dynamic paths through a network, the repeater system uses a sophisticated algorithm to propagate each RF packet through the entire network.

The network supports RF packets up to 2048 bytes when the RF data rate is set at 9600 bps (BR = 0). The repeater network can operate using broadcast or addressed communications for multi-drop networks, and it works well in many systems with no special configuration.

When in Repeater mode, the network repeats each message among all available devices exactly one time. This mechanism eliminates the need for configuring specific routes. The following figure illustrates the Repeater network topology.

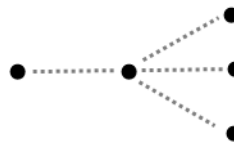

Configure a repeater network

If an RF link is weak, a device is out-of-range or a difficult RF environment is present; you can use repeaters to extend the effective range and reliability of the network.

A network may consist of End Nodes (EN), End/Repeater Nodes (ERN) and a Base Node (BN). The base node initiates all communications. Both Repeater Nodes and End Nodes can source data, allowing connection to host devices. Repeater Nodes however, are able to repeat information in a simple store and forward fashion. As an example, one End Node (which can be a base or remote) must send a message to another End Node. Because the End Node is out of range of the base device, you can use a repeater to forward information from the Base to the End Node.

You can configure a repeater network to operate using Basic Broadcast or Basic Addressed communications. The addressing capabilities of the device allow integrators to send a packet as a global packet (DT = 0xFFFF) and shift out of every device in the network (Basic Broadcast). Alternately, you can send the packet with a specific DT parameter so that only a specific remote node accepts it (Basic Addressed).

Repeater network: configure communications

To configure a Repeater network for Basic broadcast communications:

1. Assign each device a unique MY (source) address. Use the AM command to configure a unique source address based on the device serial number. This is essential because a unique packet ID on each RF packet is based on the originator's MY value.
2. Set DT = 0xFFFF to enable Basic Broadcast communications OR Basic Addressed communications (DT specifies a specific destination).
3. Configure PK, RO and RB to ensure that the RF packet aligns with the protocol packet. For example:
PK=0x100
RB=0x100
RO depends on baud rate
4. Set MD = 5 to configure one or more devices that you do not intend to be repeaters as repeater End Nodes in the system.
5. Set MD = 6 to configure remote nodes as destinations. This ensures that the remote node waits for the repeater traffic to subside before it transmits a response.

To configure a Repeater network for Basic addressed communications, use DT to assign unique addresses to each device in the network.

Repeater network algorithm details

The firmware uses an algorithm to propagate each RF packet through the entire repeater network. Within a repeater network, the firmware only defines Repeater Nodes and repeater End Nodes. Repeater Nodes forward messages on to other devices within range; End Nodes do not.

The algorithm maintains a list of messages previously received in a buffer. The firmware discards messages already in the buffer. This eliminates End Nodes receiving multiple copies of a packet from more than one source, and also eliminates multiple repeaters within range of each other from continually passing messages in an infinite loop.

Packet ID (PID) is composed of the TX (transmitting) device MY address and the packet sequence number.

The firmware ignores incoming packets with a PID already in the buffer.

Each device maintains a PID buffer 4-deep of previously received packets (managed as FIFO).

The firmware may shift packets out the serial port and/or repeat them depending on the DT parameter in the RF packet. The following table shows the basis for these decisions.

Address Match	Send out serial port?	Repeat?
Global	Yes	Yes
Local	Yes	No
None	No	Yes

Repeat delay based on RSSI

A transmitted packet may be received by more than one repeater at the same time. In order to reduce the probability that the repeaters will transmit at the same instant, resulting in a collision and possible data loss; the firmware uses an algorithm that allows a variable back-off prior to a repeater retransmitting the packet. The algorithm allows devices that receive the packet with a stronger RF signal (RSSI) to have the first opportunity to retransmit the packet.

Use the RN (Delay Slots) parameter to configure this delay. Set RN = 0 (no delays) for small networks with few repeaters or repeaters that are not within range of each other. Set RN = 1 for systems with two to five repeaters that may be within range of each other.

The actual length of the delay is computed by the formula:

$$\text{Delay (ms)} = L * DS$$

$$DS = (-41 - \text{RSSI}) / 10 * RN + \text{RandomInt}(0, RN)$$

Where L is the length of the transmitted packet in milliseconds, DS is the number of delay slots to wait, RSSI is the received signal strength in dBm, RN is the value of the RN register and RandomInt (A,B) is a function that returns a random integer from A to B-0

Response packet delay

As a packet propagates through the repeater network, if any node receives the data and generates a quick response, the network needs to delay the response so as not to collide with subsequent retransmissions of the original packet. To reduce collisions, both repeater and end node devices in a repeater network delay transmission of data shifted in the serial port to allow any repeaters within range to complete their retransmissions.

The time for this delay is computed by the formula:

$$\text{Maximum Delay (ms)} = L * DS$$

$$DS = ((-41 - (-100)) / 10) * RN + RN + 1$$

Where L is the length of the transmitted packet in milliseconds, DS is the number of delay slots to wait, RSSI is the received signal strength in dBm, and RN is the value of the RN register.

Use case - Broadcast Repeater network

Consider modems R1 through R10 each communicating to a PLC using the ModBus protocol and spaced evenly in a line. All ten modems are configured as 'destinations and repeaters' within the scope of Basic Broadcast Communications (MD=5, AM, DT=0xFFFF, PK=0x100, RO=0x03, RB=0x100, RN=1). The Base Host (BH) shifts payload that is destined for R10 to R1. R1 initializes RF communication and transmits payload to nodes R2 through R5 which are all within range of R1. The modems R2 through R5 receive the RF packet and retransmit the packet simultaneously. They also send the data out the serial ports, to the PLCs. The following table shows commands used to configure repeater functions.

AT Command	Binary Command	AT Command Name	Range	# Bytes Returned	Factory Default
AM	0x3A (58d)	Auto-set MY	-	-	-
DT	0x00 (0d)	Destination Address	0 - 0xFFFF	2	0
MD	0x3C (60d)	RF Mode	0 - 6	1	0
MY	0x2A (42d)	Source Address	0 - 0xFFFF	2	0xFFFF
RN	0x19 (25d)	Delay Slots	0 - 0xFF [slots]	1	0
WR	0x08 (8d)	Write	-	-	-

Bandwidth considerations

Using broadcast repeaters in a network reduces the overall network data throughput as each repeater must buffer an entire packet before retransmitting it. For example: if the destination is within range of the transmitter and the packet is 32-bytes long, the transmission takes 12 ms on a device operating at 115,200 baud. If the same packet must propagate through two repeaters, it takes 12 ms to arrive at the first repeater, 12 ms to get to the second and a final 12 ms to reach the destination for a total of 36 ms. Accounting for UART transfer times (~1ms/byte at 9600 baud), the time for a server to send a 32-byte query and receive a 32-byte response is about 200 ms, allowing for 5 polls per second. With the two repeaters in the path, the same query/response sequence would take about 500 ms for two polls per second.

Generally, network throughput decreases by a factor of $1/(R+1)$, with R representing the number of repeaters between the source and destination.

Polling mode (basic)

Polling mode (basic) and Polling mode (acknowledged) operate in the same way. The only difference between the two modes is in their means of achieving reliable delivery of data. Polling mode (basic) uses multiple transmissions to achieve reliable delivery.

Characteristics	<p>Uses a high percentage of available network bandwidth.</p> <p>Eliminates collisions.</p> <p>Works with reliable delivery (RR or MT parameters).</p> <p>Supports binary data transfers.</p> <p>Base device requests packets from remote device by polling a sequential range of addresses.</p> <p>Base device is configured to specify the range of addresses being polled.</p> <p>Uses inter-character delay to create RF packet lengths aligned with protocol packet lengths up to 2048 bytes long.</p>
Constraints	<p>The minimum time interval between polling cycles is configurable. However, if the remote devices cannot all be processed within that time interval, the polling cycle is ineffective (i.e. it will impose no additional delay). In order to ensure a pause between polling cycles, you must set PD to a value that is large enough to accommodate the pause.</p>
Recommended use	<p>Use for point-to-multipoint applications that require Reliable Delivery of data. Use this mode when it is critical that a base device be able to discern data coming from multiple devices.</p>
Required parameter values (Base)	<p>MD (RF Mode) = 3</p> <p>PB (Polling Begin Address)</p> <p>PE (Polling End Address)</p>
Required parameter values (Remote)	<p>MD (RF Mode) = 4</p>
Related commands	<p>Networking: MT, PD, DT, MY, and AM</p>

Polling mode theory of operation

A Polling Base device cycles through a sequential range of addresses. The Polling Base polls each Polling Remote device, waits for a response, then poll the next remote address in the sequence. Each Polling Remote responds by sending the data from its DIN buffer following the RB and RO parameters. When there is no eligible data to send, the Polling Remote does not respond. The Polling Base polls the next address in the polling sequence after a short delay.

Configure a Polling Base

To configure a device as a Polling Base:

1. Set MD = 3.
2. Set MY = 0.
3. Set the sequential range of polling addresses using PB and PE.
4. (Optional) Enable Basic Reliable Delivery ($MT \geq 0$). The firmware also supports Acknowledged Reliable Delivery. For more information, see [Polling mode \(acknowledged\)](#) on page 72.
5. (Optional) Use PD to configure a delay between polls to slow down the system, if needed.
6. (Optional) Enable API Mode to address remote devices within polling range on a packet-by-packet basis.

Configure a Polling Remote

To configure a device as a Polling Remote:

1. Set MD = 4.
2. Configure sequential source addresses for all remote devices using MY.
3. Set DT to point to the Polling Base (DT = 0x0000).
4. (Optional) Enable Basic Reliable Delivery ($MT \geq 0$). The firmware also supports Acknowledged Reliable Delivery. For more information, see [Polling mode \(acknowledged\)](#) on page 72.

Acknowledged communications: Acknowledged mode

Use Acknowledged mode for applications that need reliable delivery. If messages are smaller than 256 bytes, use the RB and RO commands to align RF packets to application packets.

Characteristics	Reliable delivery through positive acknowledgments for each packet. Throughput, latency and jitter vary depending on the quality of the channel and the strength of the signal.
Required parameter values (TX device)	RR (Retries) ≥ 1
Related commands	Networking (DT, MK, RR), Serial Interfacing (PK, RN, RO, RB, TT)

Acknowledged mode connection sequence

After sending a packet while in Acknowledged mode, the TX (transmitting) device listens for an acknowledgment (ACK). If it receives the ACK, it either moves on to sending a subsequent packet if more transmit data is pending or waits for exactly RN random delay slots before allowing another transmission if no more data is pending transmit.

If the TX device does not receive the ACK within the allotted time, it retransmits the packet with a new RF initializer following the ACK slot. There is no delay between the first ACK slot and the first retransmission. Subsequent retransmissions incur a delay of a random number of delay slots, between 0 and RN. If RN is set to 0 on the TX device, there are never any back-off delays between retransmissions. During back-off delays, the TX device goes into Idle Mode and may receive RF data. This can have the effect of increasing the back-off delay, as the device cannot return to Transmit (or retransmit) mode as long as it is receiving RF data.

After receiving and acknowledging a packet, the RX (receiving) device moves to the next frequency and listens for either a retransmission or new data for a specific period of time. Even if the TX device indicates that it has no more pending transmit data, it may not have received the previous ACK, and so may retransmit the packet, possibly with no delay after the ACK slot. In this case, the RX device always detects the immediate retransmission, which holds off the communications channel and reduces collisions. RX devices acknowledge each retransmission they receive, but they only pass the first copy of a packet they receive out the UART.

The device does not apply the RB and RO parameters to subsequent packets, meaning that once transmission begins, it continues uninterrupted until the DIN buffer is empty or it reaches the streaming limit (TT parameter). As with the first packet, the payload of each subsequent packet includes up to the maximum packet size (PK parameter), and the TX device checks for more pending data near the end of each packet.

The TT parameter specifies the maximum number of bytes that the TX device sends in one transmission event, which may consist of many packets and retries. If a device reaches the TT parameter limit, the TX device forces a random delay of 1 to RN delay slots (exactly 1 delay slot if RN is zero). Each packet counts only once toward TT, no matter how many times the packet is retransmitted.

Subsequent packets in Acknowledged mode are similar to those in Streaming mode, with the addition of an ACK between each packet, and the possibility of retransmissions. The device sends subsequent packets without an RF initializer, as the RX devices are already synchronized to the TX device from the preceding packet(s) and they remain synchronized for the duration of the transmission event. Each packet retransmission includes an RF initializer.

Once the TX device sends all pending data or reaches the TT limit, the acknowledged transmission event is complete. The TX device does not transmit again for exactly RN delay slots, if the local RN parameter is set to a non-zero value. The RX device does not transmit for a random number of delay slots between 0 and (RN-1), if the local RN parameter is set to a non-zero value. The intent of these delays is to lessen congestion following long bursts of packets from a single TX device, during which several RX devices may have themselves become ready to transmit.

Polling mode (acknowledged)

Polling mode (acknowledged) and Polling mode (basic) operate in the same way. The difference between the two modes is in their means of achieving the reliable delivery of data. In Polling mode (acknowledged), the firmware achieves reliable delivery using retries and acknowledgments.

Characteristics	<p>Uses a high percentage of available network bandwidth.</p> <p>Eliminates collisions.</p> <p>Works with reliable delivery (RR or MT parameters).</p> <p>Supports binary data transfers.</p> <p>Base device requests packets from remote device by polling a sequential range of addresses.</p> <p>Base device is configured to specify the range of addresses being polled.</p> <p>Uses inter-character delay to create RF packet lengths aligned with protocol packet lengths up to 2048 bytes long.</p>
Constraints	<p>The minimum time interval between polling cycles is configurable. However, if the remote devices cannot all be processed within that time interval, the polling cycle is ineffective (i.e. it will impose no additional delay). In order to ensure a pause between polling cycles, PD must be set to a value which is large enough to accommodate the pause.</p>
Recommended use	<p>Use for point-to-multipoint applications that require Reliable Delivery of data. Use this mode when it is critical that a base device be able to discern data coming from multiple devices.</p>
Required parameter values (Base)	<p>MD (RF Mode) = 3, PB (Polling Begin Address) PE (Polling End Address)</p>
Required parameter values (Remote)	<p>MD (RF Mode) = 4</p>
Related commands	<p>Networking (RR, PD, DT, MY, AM)</p>

For configuration and theory of operation information, see [Polling mode theory of operation](#) on page 70, [Configure a Polling Base](#) on page 70 and [Configure a Polling Remote](#) on page 70.

Agency certifications

Before installing and powering on the RF modem, read all instructions and keep these instructions in a safe place for future reference.

Changes or modifications not expressly approved by the party responsible for compliance could void the user's authority to operate the equipment.

FCC (United States) Certification

FCC Part 15 Class B

Radio Frequency Interface (RFI) (FCC 15.105)

This device has been tested and found to comply with the limits for Class B digital devices pursuant to Part 15 Subpart B of the FCC rules. These limits are designed to provide reasonable protection against harmful interference in a residential environment. This equipment generates, uses, and can radiate radio frequency energy, and if not installed and used in accordance with the instruction manual, may cause harmful interference to radio communications. However, there is no guarantee that interference will not occur in a particular installation. If this equipment does cause harmful interference to radio or television reception, which can be determined by turning the equipment off and on, the user is encouraged to try to correct the interference by one or more of the following measures:

- Reorient or relocate the receiving antenna.
- Increase the separation between the equipment and receiver.
- Connect the equipment into an outlet on a circuit different from that to which the receiver is connected.
- Consult the dealer or an experienced radio/TV technician for help.

Labeling requirements (FCC 15.19)

This device complies with Part 15 of FCC rules. Operation is subject to the following two conditions: (1) this device may not cause harmful interference, and (2) this device must accept any interference received, including interference that may cause undesired operation.

Modifications (FCC 15.21)

Changes or modifications to this equipment not expressly approved by Digi may void the user's authority to operate this equipment.

IC (Industry Canada) Certification

This device complies with Industry Canada licence-exempt RSS standard(s). Operation is subject to the following two conditions: (1) this device may not cause interference, and (2) this device must accept any interference, including interference that may cause undesired operation of the device.

Le présent appareil est conforme aux CNR d'Industrie Canada applicables aux appareils radio exempts de licence. L'exploitation est autorisée aux deux conditions suivantes: (1) l'appareil ne doit pas produire de brouillage, et (2) l'utilisateur de l'appareil doit accepter tout brouillage radioélectrique subi, même si le brouillage est susceptible d'en compromettre le fonctionnement.

RF Exposure



CAUTION! This equipment is approved for mobile and base station transmitting devices only. Antenna(s) used for this transmitter must be installed to provide a separation distance of at least 34 cm from all persons and must not be co-located or operating in conjunction with any other antenna or transmitter.



ATTENTION Cet équipement est approuvé pour la mobile et la station base dispositifs d'émission seulement. Antenne(s) utilisé pour cet émetteur doit être installé pour fournir une distance de séparation d'au moins 34 cm à partir de toutes les personnes et ne doit pas être situé ou fonctionner en conjonction avec tout autre antenne ou émetteur.

ACMA (Australia)

Power requirements

Regulations in Australia stipulate a maximum of 30 dBm EIRP (Effective Isotropic Radiated Power). The EIRP equals the sum (in dBm) of power output, antenna gain and cable loss and cannot not exceed 30 dBm.

The EIRP formula for Australia is:

$$\text{Power Output} + \text{Antenna Gain} - \text{Cable Loss} \leq 30 \text{ dBm}$$

Note The maximum EIRP for the FCC (United States) and IC (Canada) is 36 dBm.

Legacy XTend Modem FCC-approved antennas

(1-watt transmit power output or lower)

Part Number	Type	Connector	Gain	Application
A09-HSM-7 ¹	Straight half-wave	RPSMA	3.0 dBi	Fixed / Mobile
A09-HASM-675	Articulated half-wave	RPSMA	2.1 dBi	Fixed / Mobile
A09-HABMM-P6I	Articulated half-wave w/ 6" pigtail	MMCX	2.1 dBi	Fixed / Mobile
A09-HABMM-6-P6I	Articulated half-wave w/ 6" pigtail	MMCX	2.1 dBi	Fixed / Mobile
A09-HBMM-P6I	Straight half-wave w/ 6" pigtail	MMCX	2.1 dBi	Fixed / Mobile
A09-HRSM	Right angle half-wave	RPSMA	2.1 dBi	Fixed
A09-HASM-7	Articulated half-wave	RPSMA	2.1 dBi	Fixed
A09-HG	Glass mounted half-wave	RPSMA	2.1 dBi	Fixed
A09-HATM	Articulated half-wave	RPTNC	2.1 dBi	Fixed
A09-H	Half-wave dipole	RPSMA	2.1 dBi	Fixed

1. Installers should apply additional torque to screw on the antenna.

Yagi antennas (approved when operating at 1-watt power output or lower)

Part Number	Type	Connector	Gain	Required Antenna Cable Loss	Application
A09-Y6	2 Element Yagi	RPN	6.1 dBi	0.1 dB*	Fixed / Mobile
A09-Y7	3 Element Yagi	RPN	7.1 dBi	1.1 dB*	Fixed / Mobile
A09-Y8	4 Element Yagi	RPN	8.1 dBi	2.1 dB*	Fixed / Mobile
A09-Y6TM	2 Element Yagi	RPTNC	6.1 dBi	0.1 dB*	Fixed / Mobile
A09-Y7TM	3 Element Yagi	RPTNC	7.1 dBi	1.1 dB*	Fixed / Mobile
A09-Y8TM	4 Element Yagi	RPTNC	8.1 dBi	2.1 dB*	Fixed / Mobile

Omni-directional base station antennas (approved when operating at 1-watt power output or lower)

Part Number	Type	Connector	Gain	Required Antenna Cable Loss	Application
A09-F0	Fiberglass Base Station	RPN	0 dBi	-	Fixed
A09-F1	Fiberglass Base Station	RPN	1.0 dBi	-	Fixed
A09-F2	Fiberglass Base Station	RPN	2.1 dBi	-	Fixed
A09-F3	Fiberglass Base Station	RPN	3.1 dBi	-	Fixed
A09-F4	Fiberglass Base Station	RPN	4.1 dBi	-	Fixed
A09-F5	Fiberglass Base Station	RPN	5.1 dBi	-	Fixed

Part Number	Type	Connector	Gain	Required Antenna Cable Loss	Application
A09-F6	Fiberglass Base Station	RPN	6.1 dBi	0.1 dB*	Fixed
A09-F7	Fiberglass Base Station	RPN	7.1 dBi	1.1 dB*	Fixed
A09-F8	Fiberglass Base Station	RPN	8.1 dBi	2.1 dB*	Fixed
A09-W7	Wire Base Station	RPN	7.1 dBi	1.1 dB*	Fixed
A09-F0	Fiberglass Base Station	RPSMA	0 dBi	-	Fixed
A09-F1	Fiberglass Base Station	RPSMA	1.0 dBi	-	Fixed
A09-F2	Fiberglass Base Station	RPSMA	2.1 dBi	-	Fixed
A09-F3	Fiberglass Base Station	RPSMA	3.1 dBi	-	Fixed
A09-F4	Fiberglass Base Station	RPSMA	4.1 dBi	-	Fixed
A09-F5	Fiberglass Base Station	RPSMA	5.1 dBi	-	Fixed
A09-F6	Fiberglass Base Station	RPSMA	6.1 dBi	0.1 dB*	Fixed
A09-F7	Fiberglass Base Station	RPSMA	7.1 dBi	1.1 dB*	Fixed
A09-F8	Fiberglass Base Station	RPSMA	8.1 dBi	2.1 dB*	Fixed
A09-W7SM	Wire Base Station	RPSMA	7.1 dBi	1.1 dB*	Fixed
A09-F0TM	Fiberglass Base Station	RPTNC	0 dBi	-	Fixed
A09-F1TM	Fiberglass Base Station	RPTNC	1.0 dBi	-	Fixed
A09-F2TM	Fiberglass Base Station	RPTNC	2.1 dBi	-	Fixed
A09-F3TM	Fiberglass Base Station	RPTNC	3.1 dBi	-	Fixed
A09-F4TM	Fiberglass Base Station	RPTNC	4.1 dBi	-	Fixed
A09-F5TM	Fiberglass Base Station	RPTNC	5.1 dBi	-	Fixed
A09-F6TM	Fiberglass Base Station	RPTNC	6.1 dBi	0.1 dB*	Fixed
A09-F7TM	Fiberglass Base Station	RPTNC	7.1 dBi	1.1 dB*	Fixed
A09-F8TM	Fiberglass Base Station	RPTNC	8.1 dBi	2.1 dB*	Fixed
A09-W7TM	Wire Base Station	RPTNC	7.1 dBi	1.1 dB*	Fixed

* FCC regulations stipulate a 36 dBm EIRP power requirement. Users implementing antenna gain greater than 6.0 dB must compensate for the added gain with cable loss. When operating at 1 W power output, the sum (in dB) of cable loss and antenna gain shall not exceed 6.0 dB.

Mag Mount antennas (approved when operating at 1-watt power output or lower)

Part Number	Type	Connector	Gain	Required Antenna Cable Loss	Application
A09-M0SM	Mag Mount	RPSMA	0 dBi	-	Fixed
A09-M2SM	Mag Mount	RPSMA	2.1 dBi	-	Fixed
A09-M3SM	Mag Mount	RPSMA	3.1 dBi	-	Fixed
A09-M5SM	Mag Mount	RPSMA	5.1 dBi	-	Fixed
A09-M7SM	Mag Mount	RPSMA	7.1 dBi	-1.1 dB*	Fixed
A09-M8SM	Mag Mount	RPSMA	8.1 dBi	-2.1 dB*	Fixed
A09-M0TM	Mag Mount	RPTNC	0 dBi	-	Fixed
A09-M2TM	Mag Mount	RPTNC	2.1 dBi	-	Fixed
A09-M3TM	Mag Mount	RPTNC	3.1 dBi	-	Fixed
A09-M5TM	Mag Mount	RPTNC	5.1 dBi	-	Fixed
A09-M7TM	Mag Mount	RPTNC	7.1 dBi	-1.1 dB*	Fixed
A09-M8TM	Mag Mount	RPTNC	8.1 dBi	-2.1 dB*	Fixed

Multi-path antennas (approved when operating at 1-watt power output or lower)

Part Number	Type	Connector	Gain	Application
A09-DPSM-P12F	omni directional permanent mount w/ 12ft pigtail	RPSMA	3.0 dBi	Fixed
A09-D3NF-P12F	omni directional magnetic mount w/ 12ft pigtail	RPN	3.0 dBi	Fixed
A09-D3SM-P12F	omni directional w/ 12ft pigtail	RPSMA	3.0 dBi	Fixed
A09-D3PNF	omni directional permanent mount	RPN	3.0 dBi	Fixed
A09-D3TM-P12F	omni directional w/ 12ft pigtail	RPTNC	3.0 dBi	Fixed
A09-D3PTM	omni directional permanent mount	RPTNC	3.0 dBi	Fixed
A92-D4PNF	900 MHz / 2.4GHz permanent mount	RPN	2.1 dBi	Fixed
A92-D4P	900 MHz / 2.4GHz permanent mount	RPSMA	2.1 dBi	Fixed
A92-D4PTM	900 MHz / 2.4GHz permanent mount	RPTNC	2.1 dBi	Fixed

* FCC regulations stipulate a 36 dBm EIRP power requirement. Users implementing antenna gain greater than 6.0 dB must compensate for the added gain with cable loss. When operating at 1 W power output, the sum (in dB) of cable loss and antenna gain shall not exceed 6.0 dB.

Half-wave antennas (approved when operating at 100 mW power output or lower)

Part Number	Type	Connector	Gain	Application
A09-QW	Quarter-wave wire	Permanent	1.9 dBi	Fixed / Mobile
A09-QRAMM	3 " Quarter-wave wire	MMCX	2.1 dBi	Fixed / Mobile
A09-QSM-3	Quarter-wave straight	RPSMA	1.9 dBi	Fixed / Mobile
A09-QSM-3H	Heavy duty quarter-wave straight	RPSMA	1.9 dBi	Fixed / Mobile
A09-QBMM-P6I	Quarter-wave w/ 6" pigtail	MMCX	1.9 dBi	Fixed / Mobile
A09-QHRN	Miniature Helical Right Angle solder	Permanent	-1 dBi	Fixed / Mobile
A09-QHSN	Miniature Helical Right Angle solder	Permanent	-1 dBi	Fixed / Mobile
A09-QHSM-2	2" Straight	RPSMA	1.9 dBi	Fixed / Mobile
A09-QHRSM-2	2" Right angle	RPSMA	1.9 dBi	Fixed / Mobile
A09-QHRSM-170	1.7" Right angle	RPSMA	1.9 dBi	Fixed / Mobile
A09-QRSM-380	3.8" Right angle	RPSMA	1.9 dBi	Fixed / Mobile
A09-QAPM-520	5.2" Articulated Screw mount	Permanent	1.9 dBi	Fixed / Mobile
A09-QSPM-3	3" Straight screw mount	Permanent	1.9 dBi	Fixed / Mobile
A09-QAPM-3	3" Articulated screw mount	Permanent	1.9 dBi	Fixed / Mobile
A09-QAPM-3H	3" Articulated screw mount	Permanent	1.9 dBi	Fixed / Mobile

Yagi antennas (approved when operating at 100 mW power output or lower)

Part Number	Type	Connector	Gain	Application
A09-Y6	2 Element Yagi	RPN	6.1 dBi	Fixed / Mobile
A09-Y7	3 Element Yagi	RPN	7.1 dBi	Fixed / Mobile
A09-Y8	4 Element Yagi	RPN	8.1 dBi	Fixed / Mobile
A09-Y9	4 Element Yagi	RPN	9.1 dBi	Fixed / Mobile
A09-Y10	5 Element Yagi	RPN	10.1 dBi	Fixed / Mobile
A09-Y11	6 Element Yagi	RPN	11.1 dBi	Fixed / Mobile
A09-Y12	7 Element Yagi	RPN	12.1 dBi	Fixed / Mobile
A09-Y13	9 Element Yagi	RPN	13.1 dBi	Fixed / Mobile
A09-Y14	10 Element Yagi	RPN	14.1 dBi	Fixed / Mobile
A09-Y14	12 Element Yagi	RPN	14.1 dBi	Fixed / Mobile
A09-Y15	13 Element Yagi	RPN	15.1 dBi	Fixed / Mobile
A09-Y15	15 Element Yagi	RPN	15.1 dBi	Fixed / Mobile
A09-Y6TM	2 Element Yagi	RPTNC	6.1 dBi	Fixed / Mobile
A09-Y7TM	3 Element Yagi	RPTNC	7.1 dBi	Fixed / Mobile
A09-Y8TM	4 Element Yagi	RPTNC	8.1 dBi	Fixed / Mobile
A09-Y9TM	4 Element Yagi	RPTNC	9.1 dBi	Fixed / Mobile
A09-Y10TM	5 Element Yagi	RPTNC	10.1 dBi	Fixed / Mobile
A09-Y11TM	6 Element Yagi	RPTNC	11.1 dBi	Fixed / Mobile
A09-Y12TM	7 Element Yagi	RPTNC	12.1 dBi	Fixed / Mobile
A09-Y13TM	9 Element Yagi	RPTNC	13.1 dBi	Fixed / Mobile
A09-Y14TM	10 Element Yagi	RPTNC	14.1 dBi	Fixed / Mobile
A09-Y14TM	12 Element Yagi	RPTNC	14.1 dBi	Fixed / Mobile
A09-Y15TM	13 Element Yagi	RPTNC	15.1 dBi	Fixed / Mobile
A09-Y15TM	15 Element Yagi	RPTNC	15.1 dBi	Fixed / Mobile

XTend vB Modem FCC-approved antennas (30 dBm Maximum RF power)

The following tables cover the antennas that are approved for use with the XBee-PRO XTC RF modules. If applicable, the tables show the required cable loss between the device and the antenna.

Digi does not carry all of these antenna variants. Contact Digi Sales for available antennas.

Dipole antennas

All antenna part numbers followed by an asterisk (*) are not available from Digi. Consult with an antenna manufacturer for an equivalent option.

Part Number	Type	Connector	Gain	Application
A09-HSM-7	Straight half-wave	RPSMA	2.1 dBi	Fixed / Mobile
A09-HASM-675	Articulated half-wave	RPSMA	2.1 dBi	Fixed / Mobile
A09-HABMM-P5I	Swivel half wave with 5" pigtail	MMCX	2.1 dBi	Fixed / Mobile
A09-HBMM-P5I	Straight half-wave with 6" pigtail	MMCX	2.1 dBi	Fixed / Mobile
A09-HASM-7	Articulated half-wave	RPSMA	2.1 dBi	Fixed
A09-HRSM*	Right angle half-wave	RPSMA	2.1 dBi	Fixed
A09-HG*	Glass mounted half-wave	RPSMA	2.1 dBi	Fixed
A09-HATM*	Articulated half-wave	RPTNC	2.1 dBi	Fixed
A09-H*	Half-wave dipole	RPSMA	2.1 dBi	Fixed

Yagi antennas

All antenna part numbers followed by an asterisk (*) are not available from Digi. Consult with an antenna manufacturer for an equivalent option.

Part Number	Type	Gain	Connector	Required Antenna Cable Loss	Application
A09-Y6NF*	2 element Yagi	6.1 dBi	N	2.0 dB	Fixed/Mobile
A09-Y7NF*	3 element Yagi	7.1 dBi	N	3.0 dB	Fixed/Mobile
A09-Y8NF	4 element Yagi	8.1 dBi	N	4.0 dB	Fixed/Mobile
A09-Y9NF*	4 element Yagi	9.1 dBi	N	5.0 dB	Fixed/Mobile
A09-Y10NF*	5 element Yagi	10.1 dBi	N	6.0 dB	Fixed/Mobile
A09-Y11NF	6 element Yagi	11.1 dBi	N	7.0 dB	Fixed/Mobile
A09-Y12NF*	7 element Yagi	12.1 dBi	N	8.0 dB	Fixed/Mobile
A09-Y13NF*	9 element Yagi	13.1 dBi	N	9.0 dB	Fixed/Mobile
A09-Y14NF*	14 element Yagi	14.0 dBi	N	9.9 dB	Fixed/Mobile

Part Number	Type	Gain	Connector	Required Antenna Cable Loss	Application
A09-Y6TM*	2 element Yagi	6.1 dBi	RPTNC	2.0 dB	Fixed/Mobile
A09-Y7TM*	3 element Yagi	7.1 dBi	RPTNC	3.0 dB	Fixed/Mobile
A09-Y8TM*	4 element Yagi	8.1 dBi	RPTNC	4.0 dB	Fixed/Mobile
A09-Y9TM*	4 element Yagi	9.1 dBi	RPTNC	5.0 dB	Fixed/Mobile
A09-Y10TM-P10I	5 element Yagi	10.1 dBi	RPTNC	6.0 dB	Fixed/Mobile
A09-Y11TM*	6 element Yagi	11.1 dBi	RPTNC	7.0 dB	Fixed/Mobile
A09-Y12TM*	7 element Yagi	12.1 dBi	RPTNC	8.0 dB	Fixed/Mobile
A09-Y13TM*	9 element Yagi	13.1 dBi	RPTNC	9.0 dB	Fixed/Mobile
A09-Y14TM*	14 element Yagi	14.0 dBi	RPTNC	9.9 dB	Fixed/Mobile

Omni-directional base station antennas

All antenna part numbers followed by an asterisk (*) are not available from Digi. Consult with an antenna manufacturer for an equivalent option.

Part Number	Type	Gain	Connector	Required Antenna Cable Loss	Application
A09-F0NF*	Fiberglass Base Station	0 dBi	N	-	Fixed
A09-F1NF*	Fiberglass Base Station	1.0 dBi	N	-	Fixed
A09-F2NF-M	Fiberglass Base Station	2.1 dBi	N	-	Fixed
A09-F3NF*	Fiberglass Base Station	3.1 dBi	N	-	Fixed
A09-F4NF*	Fiberglass Base Station	4.1 dBi	N	-	Fixed
A09-F5NF-M	Fiberglass Base Station	5.1 dBi	N	-	Fixed
A09-F6NF*	Fiberglass Base Station	6.1 dBi	N	0.9 dB	Fixed
A09-F7NF*	Fiberglass Base Station	7.1 dBi	N	1.9 dB	Fixed
A09-F8NF-M	Fiberglass Base Station	8.1 dBi	N	2.9 dB	Fixed
A09-F0SM*	Fiberglass Base Station	0 dBi	RPSMA	-	Fixed
A09-F1SM*	Fiberglass Base Station	1.0 dBi	RPSMA	-	Fixed
A09-F2SM*	Fiberglass Base Station	2.1 dBi	RPSMA	-	Fixed
A09-F3SM*	Fiberglass Base Station	3.1 dBi	RPSMA	-	Fixed
A09-F4SM*	Fiberglass Base Station	4.1 dBi	RPSMA	-	Fixed
A09-F5SM*	Fiberglass Base Station	5.1 dBi	RPSMA	-	Fixed

Part Number	Type	Gain	Connector	Required Antenna Cable Loss	Application
A09-F6SM*	Fiberglass Base Station	6.1 dBi	RPSMA	0.9 dB	Fixed
A09-F7SM*	Fiberglass Base Station	7.1 dBi	RPSMA	1.9 dB	Fixed
A09-F8SM*	Fiberglass Base Station	8.1 dBi	RPSMA	2.9 dB	Fixed
A09-F0TM*	Fiberglass Base Station	0 dBi	RPTNC	-	Fixed
A09-F1TM*	Fiberglass Base Station	1.0 dBi	RPTNC	-	Fixed
A09-F2TM*	Fiberglass Base Station	2.1 dBi	RPTNC	-	Fixed
A09-F3TM*	Fiberglass Base Station	3.1 dBi	RPTNC	-	Fixed
A09-F4TM*	Fiberglass Base Station	4.1 dBi	RPTNC	-	Fixed
A09-F5TM*	Fiberglass Base Station	5.1 dBi	RPTNC	-	Fixed
A09-F6TM*	Fiberglass Base Station	6.1 dBi	RPTNC	0.9 dB	Fixed
A09-F7TM*	Fiberglass Base Station	7.1 dBi	RPTNC	1.9 dB	Fixed
A09-F8TM*	Fiberglass Base Station	8.1 dBi	RPTNC	2.9 dB	Fixed
A09-W7*	Wire Base Station	7.1 dBi	RPN	1.9 dB	Fixed
A09-W7SM*	Wire Base Station	7.1 dBi	RPSMA	1.9 dB	Fixed
A09-W7TM*	Wire Base Station	7.1 dBi	RPTNC	1.9 dB	Fixed

Dome antennas

All antenna part numbers followed by an asterisk (*) are not available from Digi. Consult with an antenna manufacturer for an equivalent option.

Part Number	Type	Gain	Connector	Required Antenna Cable Loss	Application
A09-D3PNF*	Omnidirectional permanent mount	3.0 dBi	N	0.4 dB	Fixed/Mobile
A09-D3NF*	Omnidirectional magnetic mount	3.0 dBi	N	0.4 dB	Fixed/Mobile
A09-D3PTM*	Omnidirectional permanent mount	3.0 dBi	RPTNC	0.4 dB	Fixed/Mobile
A09-D3PSM*	Omnidirectional permanent mount	3.0 dBi	RPSMA	0.4 dB	Fixed/Mobile

Monopole antennas

All antenna part numbers followed by an asterisk (*) are not available from Digi. Consult with an antenna manufacturer for an equivalent option.

Part Number	Type	Gain	Connector	Required Antenna Cable Loss	Application
A09-QRAMM	3" Quarter wave wire	2.1 dBi	MMCX	-	Fixed/Mobile
A09-QRSM-2.1*	Quarter wave 2.1" right angle	3.3 dBi	RPSMA	0.4 dB	Fixed/Mobile
A09-QW*	Quarter wave wire	1.9 dBi	Permanent	-	Fixed/Mobile
A09-QSM-3*	Quarter wave straight	1.9 dBi	RPSMA	-	Fixed/Mobile
A09-QSM-3H*	Heavy duty quarter wave straight	1.9 dBi	RPSMA	-	Fixed/Mobile
A09-QBMM-P6I*	Quarter wave w/ 6" pigtail	1.9 dBi	MMCX	-	Fixed/Mobile
A09-QHSM-2*	2" straight	1.9 dBi	RPSMA	-	Fixed/Mobile
A09-QHRSM-2*	2" right angle	1.9 dBi	RPSMA	-	Fixed/Mobile
A09-QHRSM-170*	1.7" right angle	1.9 dBi	RPSMA	-	Fixed/Mobile
A09-QRSM-380*	3.8" right angle	1.9 dBi	RPSMA	-	Fixed/Mobile
A09-QAPM-520*	5.2" articulated screw mount	1.9 dBi	Permanent	-	Fixed/Mobile
A09-QSPM-3*	3" straight screw mount	1.9 dBi	Permanent	-	Fixed/Mobile
A09-QAPM-3*	3" articulated screw mount	1.9 dBi	Permanent	-	Fixed/Mobile
A09-QAPM-3H*	3" articulated screw mount	1.9 dBi	Permanent	-	Fixed/Mobile