



# Remote Wireless Networking 101

Everything You Need to Know to Select and  
Deploy Devices on CDMA and GSM Networks

*Making*  
**DEVICE NETWORKING**  
*easy™*



## Table of Contents

1	Overview .....	3
1.1	Key Topics .....	3
1.2	Introduction.....	3
2	Wireless Data Technology.....	4
2.1	Data Offerings .....	4
2.2	Early Wireless Data Solutions .....	5
2.3	Wireless Data Performance .....	6
2.4	Cost .....	8
2.5	IP Considerations for Wireless Networks .....	8
2.6	Persistent Connections .....	10
2.7	Product Offerings .....	11
3	Wireless Data Applications.....	14
3.1	Primary Network Connection.....	14
3.2	Backup Network Connection .....	15
3.3	Mobile Initiated Application.....	15
3.4	Mobile Terminated Application .....	16
4	Pre-Deployment Considerations .....	17
4.1	Security .....	17
4.2	Coverage.....	18
4.3	Antenna Selection .....	18
5	Complete Wireless Solution.....	20
5.1	Hardware and Distribution .....	20
5.2	Wireless Carriers .....	20
5.3	Managing Remote Devices.....	21
6	Glossary of Terms .....	23



## 1 Overview

The purpose of this document is to provide an overview of remote wireless data communications over GSM and CDMA networks.

### 1.1 Key Topics

- An introduction to remote wireless data networks
- Remote wireless data applications
- Remote wireless carrier selection
- IP addressing options
- Provisioning remote wireless devices
- Pre-deployment considerations
- Managing remote wireless devices

### 1.2 Introduction

Never before has there been such a compelling reason to connect remote devices. Customers have been waiting for the right time to finally jump on the wireless data bandwagon and a series of circumstances have converged to make today the best time to begin the process of wirelessly connecting remote devices.

Some of the reasons why this is a good time to evaluate wireless solutions are that:

- Wireless data networks are getting faster
- Data plan costs have plummeted
- Coverage area has increased substantially
- Networks have become more reliable
- Customers are seizing this opportunity to address challenges they are seeing in business:
  - Need to differentiate from competition
  - Need real-time access to device data
  - Need to create revenue from service offerings
  - Customers wanting easy/inexpensive access to data

Digi International is known for making connectivity to devices easy and we have now extended this capability to remote devices using GSM and CDMA wireless networks. New products such as Digi Connect WAN and Digi Connect Remote Gateway (RG) break new ground in making sure that customers can now access virtually any device, anywhere.



## 2 Wireless Data Technology

### 2.1 Data Offerings

The dominant cellular/PCS technologies in both North America and internationally are GSM (Global System for Mobile communications) and CDMA (Code Division Multiple Access), with GSM having the largest international presence. Cellular and PCS (Personal Communication Services) differ primarily in their respective operational frequency band. Cellular operates in the 800MHz band and PCS operates in the 1900MHz frequency band. In Europe and certain Latin America countries, GSM networks operate in the 900 MHz, 1800 MHz and 2100 MHz (UMTS) frequency bands. There are also some new CDMA networks in Eastern Europe and Asia deploying in the 450 MHz band. This document will refer to cellular and PCS technology collectively as wireless.

Both GSM and CDMA have evolved with technology improvements in what is called "Generations", or "G" (i.e. 1G, 2G, and 3G), with fractional Generations recognized for the second Generation (i.e. 2.5G, 2.75G). With each technology improvement, comes higher data rates and network enhancements. Table 1 indicates the evolution path for GSM and CDMA.

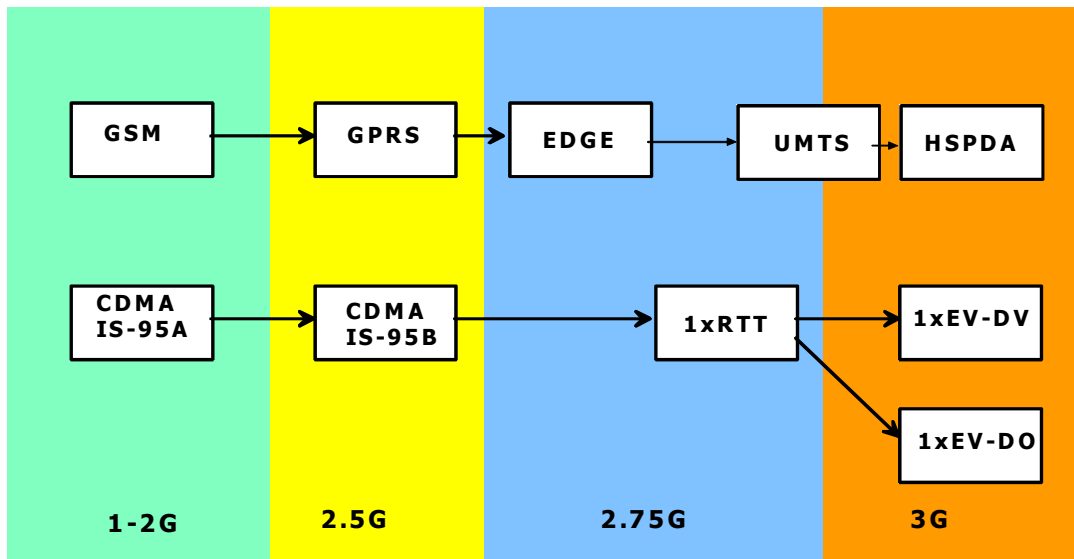

Table 1

GPRS (General Packet Radio Service) is widely deployed around the world and many operators offer EDGE (Enhanced Data rates of Global Evolution), or plan to offer EDGE.

## 2.2 Early Wireless Data Solutions

The first wireless data solutions were circuit switched and worked the same way dial-up modem to modem communications work. These wireless modems operated in the voice channel, which means throughput was very slow and airtime was very expensive. In addition, wireless modems required an analog (POTS) modem at the opposite end of the connection.

Although the Digi Connect WAN and Digi Connect RG are able to emulate a wireless modem, they actually do much more. Digi Connect WAN/RG are intelligent gateways with a full TCP/IP stack and embedded Real Time Operating System (RTOS) which allow remote devices and networks to be natively integrated with IP devices and applications across high speed digital wireless networks.

Another major difference is that applications can natively connect to remote devices using TCP/IP without having to use a standard analog modem at one end and a wireless modem at the other.

### Example of a Serial Device Connection using a Standard Wireless Modem (Notice a modem is required at both ends)

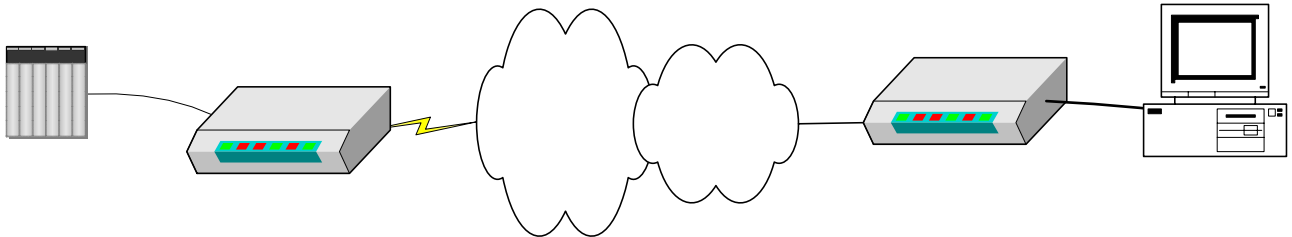

### Example: Serial Device Connection using a Digi Connect RG over an IP network (Serial device communicates directly to application server using TCP/IP)

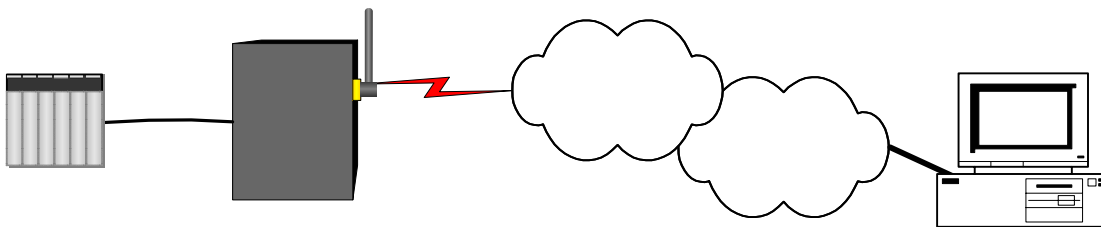



## 2.3 Wireless Data Performance

As technology has changed from circuit switched networks to packet data, so has the data throughput performance. Table 2 indicates how these wireless technologies have improved the peak data rates and to what extent packet data technology has increased the efficiency of the wireless data technology. Early circuit switched technology as described in the previous section, required a continuous, non-shared radio link connection to the wireless network. Packet data networks provide a more optimal solution by allocating the shared radio link resources only as needed during packet transmissions.

### Column Definitions

- **Generation:** Terminology used to broadly describe the first, second and third generations of wireless technology.
- **Connection Type:** Identifies if circuit switched or packet switched technology is used.
- **Theoretical Max.:** Based on GSM/CDMA technical specifications
- **Carrier Max.:** Carrier deployments for some technologies do not support the maximum Coding Scheme or Data Rate of that technology specification. This results in a reduction of the maximum throughput relative to the specification.
- **Typical Throughput:** In real world scenarios, wireless throughput is further reduced due to network congestion, fading, weather conditions, and noisy environments.



### Wireless Data Performance

Technology	Generation	Connection Type	Theoretical Max Kbps	Carrier Max Kbps	Typical Throughput Kbps
GSM	1G	Circuit	----	9.6	----
CDMA	2G	Circuit	----	14.4	----
GSM GPRS Class 6	2.5G	Packet	64.4	40.6	15-30
GSM GPRS Class 10	2.5G	Packet	86.2	54.2	20-40
GSM GPRS Class 12**	2.5G	Packet	86.2	54.2	20-40
CDMA 1xRTT	2.75G	Packet	307	153	60-80
GSM Edge Class 2	2.75G	Packet	118	118	40-80
GSM Edge Class 10	2.75G	Packet	237	237	80-160
GSM Edge Class 12**	2.75G	Packet	237	237	80-160
UMTS (W-CDMA)	3G	Packet	384	384	TBD
1xEVDO (CDMA2000)	3G	Packet	> 2000	>2000	300 – 500
HSDPA	3G	Packet	> 2000	>2000	TBD

\*\* Same overall performance as class 10 with improved uplink performance.

Table 2

## 2.4 Cost

Cost is an important factor when deciding to deploy wireless data connectivity solutions. Fortunately, data plan costs have fallen significantly, creating a more compelling reason for switching to wireless data networks for remote device communications. In addition, Digi has taken advantage of new wireless technology that maintains an “always-on” connection without paying for the airtime; therefore customers only pay for the data they actually send over the wireless connection.

Wireless carriers typically charge customers by the number of megabytes (Mb) or Kilobytes (Kb) transmitted per month. These rate plans vary from carrier to carrier but typically involve several rate plan options structured in the following format.

*\$X per month for up to Y Mb data + \$Z per Kb over Y*

Other rate plan options are also available depending on the specific carrier and application usage profile. These plans may include provisions for unlimited usage, data pooling (usage spread across a number of devices), or time-of-day discounts. Monthly charges of \$7.99 for 1MB to \$79.99 for unlimited data access are typical rates. However, depending on data usage plans can be more or less expensive. For more information about data plans, please visit an updated list of Digi wireless provider partners at <http://www.digi.com/applications/remotedevicemanagement/solutionpartners.jsp>.

## 2.5 IP Considerations for Wireless Networks

Additional consideration must be given in wireless applications regarding which side of the connection initiates communication. Each wireless carrier handles usage and management of IP addresses differently. Therefore customers must be prepared to carefully examine the type of IP connectivity options available and make sure that they work with the targeted application.

### Mobile Originated vs. Mobile Terminated Applications

When the remote device initiates communication to the host, this is referred to as a mobile originated application. Applications such as Wireless WANs often use a mobile originated application, since the remote network initiates the connection to the home office.

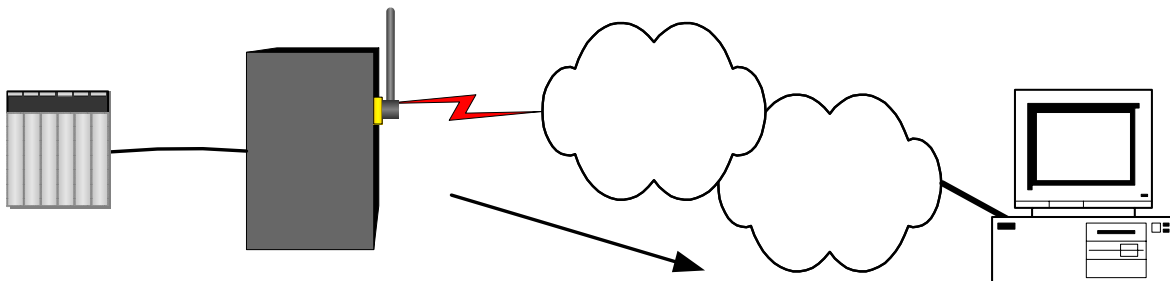

Mobile Originated – Remote Device initiates connection



Conversely, when the host initiates communication to the remote device, this is referred to as a mobile terminated application. This is common in telemetry applications where a host (or master) must initiate communications with the remote (or slave) device.

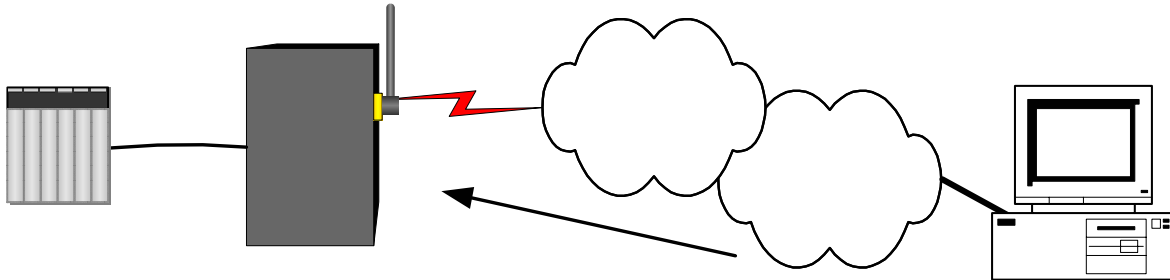

Mobile Terminated – Host initiates connection

### Public vs. Private IP Addresses

This is important because mobile termination requires a 'reachable' IP address, meaning that the host has access to the remote IP address. One way to accomplish this is with a Public IP address. A public IP address is an IP that is generally reachable by anyone on the Internet. However one problem with public IP addresses is that wireless carriers have a limit to the number of IP addresses they are capable of issuing, therefore public IP's can be very expensive. Because of this most IP addresses associated with wireless data plans actually hand out private IP addresses that are not reachable by others around the Internet. In general, private IP addresses do allow the remote devices access to the Internet. Therefore private IP addresses work just fine for mobile originated applications.

### Static vs. Dynamic IP Addresses

The demand for public IP addresses continues to grow, however there are only a finite number of public IP addresses available, therefore wireless carriers have resorted to handing out dynamic IP addresses instead of static or fixed public addresses to solve the problem.

With dynamic IP addresses, each device is given an IP address for a limited period of time, which is usually no more than a few hours, and then the IP address is changed. By using dynamic IP addressing schemes, carriers effectively solve their problem of not having a sufficient quantity of fixed IP addresses to meet market demand. This however creates a challenge for the users with mobile terminated applications who need a fixed address to target.

Fortunately, solutions to all of the challenges above are available using Digi products and Digi partner technology. First, the network connection type between the carrier network infrastructure and the customers' data center can provide some flexibility. For example, a frame relay or VPN connection between the carrier network and the customers' data center allows remote devices to use private IP address assignments for mobile terminated application connections.

Remote  
Device

### Dynamic DNS Services

Additionally, Dynamic Domain Name Services (DDNS) are available that solve the problem associated with ever changing dynamic IP addresses in applications where customer require a mobile terminated connection. A DDNS server maps a static hostname to the remote device, so that no matter how often the IP address of that device changes, the host name still points to the same device.

Some carriers offer network specific DDNS servers, however Digi also offers a cross-network DDNS solution through its Digi Connectware Manager platform. This feature allows the devices to report IP address changes to the Digi Connectware Manager server which in turn sends updates to a designated DNS server. This DDNS architecture approach also utilizes keep-alive messages between the device and Digi Connectware Manager to maintain current IP address accuracy.

## 2.6 Persistent Connections

The nature of wireless connections relative to wired connections is that they operate in a more intermittent environment. This intermittence is due to a number of factors, including RF signal loss caused by fading, interference, and moving obstructions. Additional connection loss is due to the wireless carriers' practice of terminating inactive user/data sessions. Typically, the wireless device is not notified when a connection is terminated due to data inactivity.

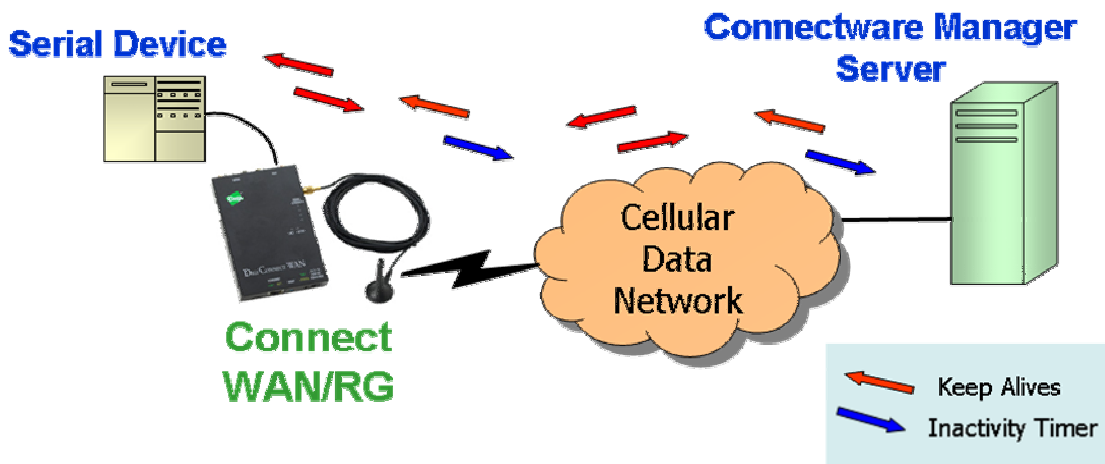

Maintaining persistent mobile connections are important for multiple reasons. With mobile terminated applications, if the host tries to communicate with a remote device and the mobile link is down, the connection attempt will fail. The keep-alive function insures the connection will be there when needed.

With mobile originated applications, an inactive mobile link may not appear to be as critical since a new link would be initiated when data is ready to be sent. However, the time needed to re-initiate the mobile PPP connection can take several seconds. A persistent connection means that data will be sent immediately.

Digi Connect™ devices use the unique Digi SureLink™ capabilities for proving an always-on connection that helps to mitigate these types of connection losses. A programmable



inactivity timer and a pro-active link integrity function are available on both the Digi Connect WAN and Digi Connect RG devices.

Digi Connect WAN devices can be set to maintain persistent connections by simply re-establishing the mobile PPP connection when the inactivity timer expires. No data is actually sent or received over the airwaves when doing this, and since most wireless data plans charge by amount of data transferred and not by connection time, no additional data charges are incurred.

The Digi Connectware Manager platform, which is used to manage many Connect WAN/RG devices, adds enhanced keep-alive capabilities between the Connect WAN/RG and the Digi Connectware Manager Server. The Digi Connectware Manager sends TCP keep-alive packets (pair=138 bytes), at a configurable interval, to the remote Digi Connect WAN/RG device in order to maintain a persistent connection.

Digi Connect devices can also be configured to launch keep-alive packets from the remote side to the network in order to ensure the connection stays open and available for instant communications. Keep-alive packets from the Digi Connect WAN/RG are also used to inform the Digi Connectware Manager (enterprise remote device management application) of the connection status of the device as well as facilitating stale connection cleanup. Additionally, the Digi Connect devices can be configured to expect keep-alive packets from Connectware and are able to re-establish a connection if keep-alive packets from Connectware have not arrived for some time.

## **2.7 Product Offerings**

### **2.7.1 Digi Connect WAN – Ethernet to Wireless Gateway/Router**

The Digi Connect WAN is a wireless Wide Area Network (WAN) gateway/router, which provides an alternative to traditional wired TCP/IP, utilizing wireless technology to create primary or backup network connections. The Digi Connect WAN offers an easy and cost-effective means of connecting virtually any remote location or device into the corporate IP network. It is ideal for use where wired networks (e.g., lease line/frame relay, CSU/DSU, fractional T1) are not feasible or where alternative network connections are required.



The Digi Connect WAN functions as a router/gateway, passing IP traffic to/from the Digi Connect WAN Ethernet port to the wireless data network. Typical applications include, but are not limited to:

- Remote site wireless backup connectivity to a main wide-area network (WAN) connection such as frame relay or VPN connection.
- Remote site primary wireless WAN connectivity for small networks.
- Remote site wireless connectivity of Ethernet based devices.

Features of the Connect WAN include:

- GSM GPRS/EDGE or CDMA 2000 1xRTT Interface
- 10/100 Mbps Ethernet interface
- Routing/Firewall Features
  - Network Address Translation (NAT) which allows private IP addresses to be used on the Ethernet interface of the Digi Connect WAN.
  - TCP/UDP Port Forwarding to direct traffic from the mobile interface to devices or systems connected to the Ethernet interface.
  - Access Control Lists to limit IP addresses with access to the Digi Connect device
  - VPN pass-through to allow protocols like GRE and IPSEC to transparently travel through the router to connect to VPN appliances
  - IPSEC VPN Endpoint (client & server) with selectable DES, 3DES, and 256-bit AES Encryption, and MD5 Authentication (coming soon)
- Digi SureLink™ connection maintains network for rapid on-demand communications
- Configuration via web interface, or remote device configuration via Digi Connectware Manager enterprise software

### 2.7.2 Digi Connect Remote Gateway (RG) – Serial to Wireless Gateway

The Digi Connect RG provides serial device connectivity over a wireless connection. The Digi Connect RG utilizes wireless networks to connect virtually any RS-232/422/485 serial device to TCP/IP networks. It allows remote devices to communicate easily and cost-effectively to a central site or application through standard TCP/UDP communications. In addition, Digi's patented RealPort® COM/TTY port redirection software supports remote connections to serial devices as if they were actually connected to local COM ports.



The Digi Connect RG provides serial to wireless connectivity for applications such as remote telemetry, monitoring and control of serial-based devices.

Features of the Digi Connect RG include:

- GSM GPRS/EDGE or CDMA 2000 1xRTT interface
- 10/100 Mbps Ethernet for configuration
- RS232, RS422, RS485 serial port for device connection
- TCP/UDP socket connections
- RealPort® COM port redirection
- Telnet/Reverse Telnet, SSH, SSL
- Digi SureLink™ connection maintains network for rapid on-demand communications
- Configuration via web interface, or remote device configuration via Digi Connectware Manager enterprise software

### 3 Wireless Data Applications

The Digi Connect WAN and Digi Connect RG are designed to fit a variety of applications. The usage scenarios and diagrams shown below reflect some of the most common applications.

#### 3.1 Primary Network Connection

A primary network connection application provides wireless access to one or more computers at a remote site. A secure connection can be established with a GRE or VPN tunnel through the Digi Connect WAN onto the wireless network.

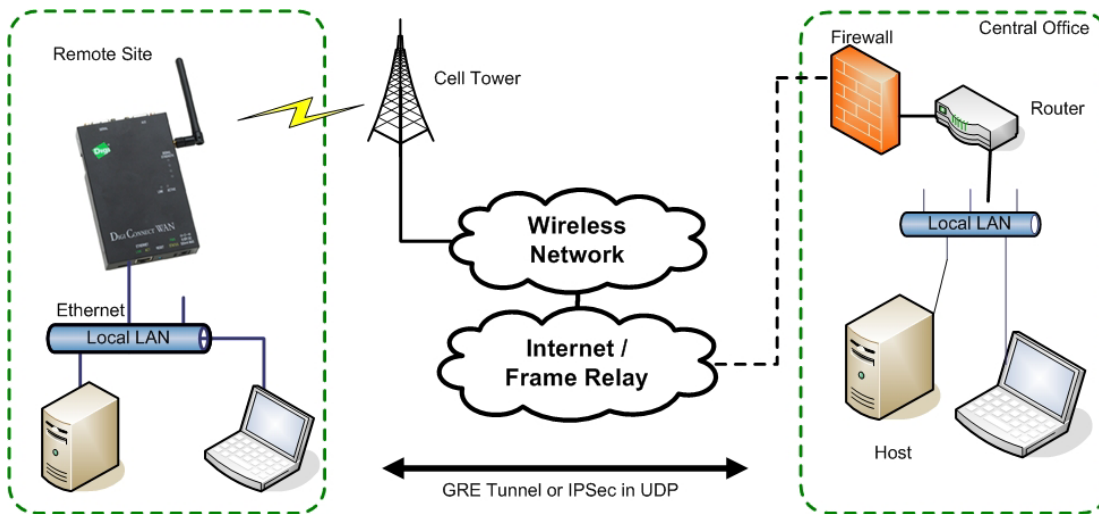

### 3.2 Backup Network Connection

A secondary network connection application utilizes a traditional wire-line connection (frame relay, leased line, ISDN T1, etc) connection as the primary access to a remote site and a wireless connection as a backup connection. When the primary connection goes down, network traffic is seamlessly routed through the Digi Connect WAN over the wireless network.

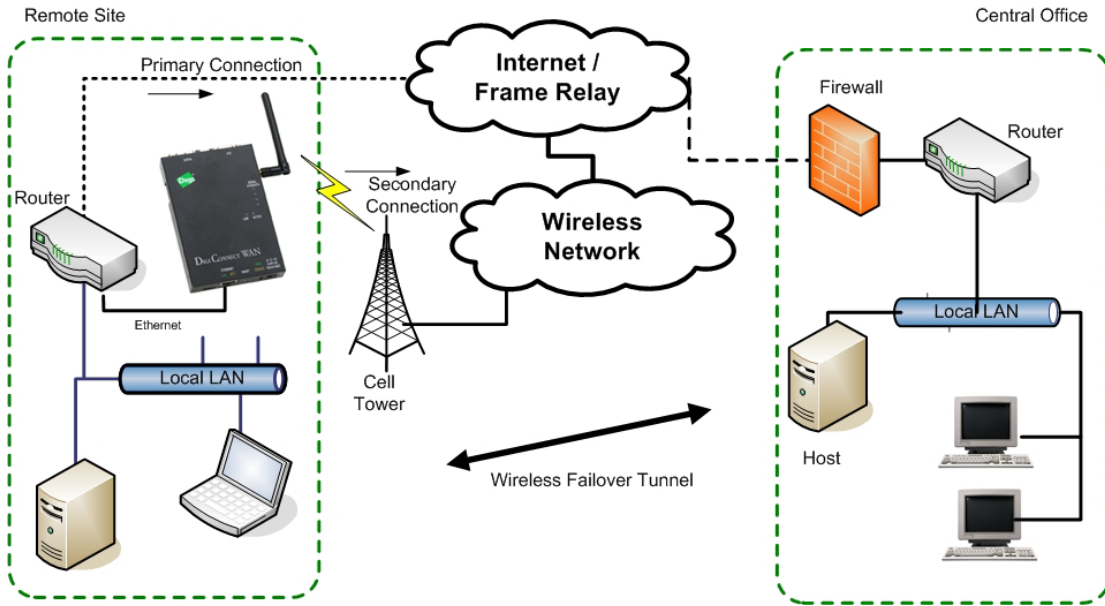

### 3.3 Mobile Initiated Application

A mobile initiated application is defined as one where network traffic is only initiated at the remote location. This scenario is suitable for devices that periodically upload data to a host computer.

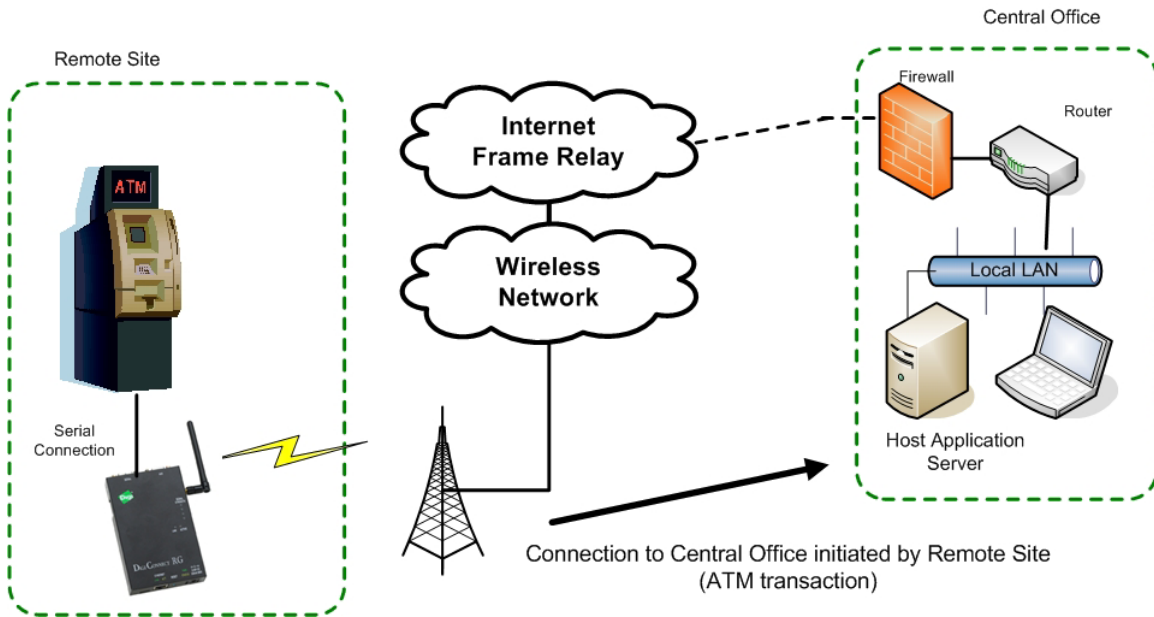

### 3.4 Mobile Terminated Application

A mobile terminated application is defined as one where network traffic to a remote location is initiated at the host end. This scenario is suitable for applications such as SCADA where host application is required to poll the remote device for information via the Digi Connect WAN.

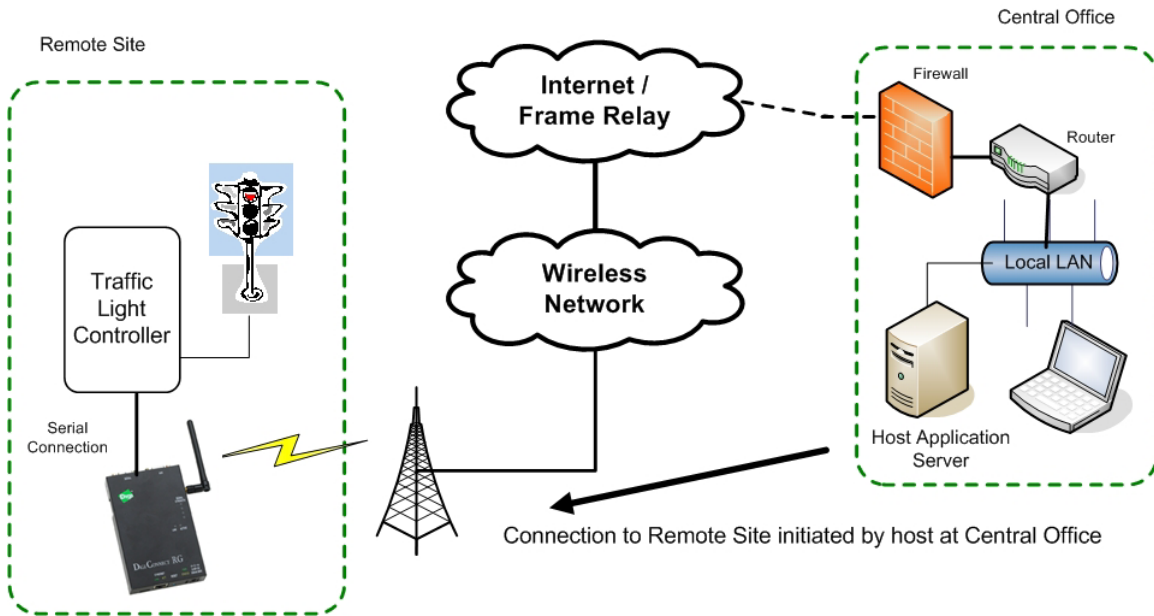





## 4 Pre-Deployment Considerations

The following are recommendations that users should understand before deploying remote wireless data device. The purpose of this section is to ensure customers consider the important details which are crucial for a rollout onto a GSM or CDMA network.

### 4.1 Security

Security is a consideration for virtually everyone deploying in remote environments today. Fortunately there are advantages built into GSM and CDMA networks that make the data communications inherently more secure than many other types of wireless networks. However, when considering a remote wireless deployment there are several factors to contemplate. One should not only be concerned with securing the data, but also securing the management of the remote devices. Digi addresses each of these with the following features:

- Wireless data networks themselves provide Over-The-Air (OTA) encryption to protect the wireless data path.
- Carriers offer virtual private network (VPN) or frame relay connection options between their wireless network and the subscriber's network. These methods secure the wired portion of the data path. Many data focused Mobile Virtual Network Operators (MVNO) are also capable of providing VPN connections for private network access.
- Additional end-to-end security can be implemented between the remote site and the Subscriber's central office. This can be simple SSL security via HTTPS, or PPTP or IPSEC VPN's. The current Digi Connect WAN provides VPN pass-through capabilities via GRE, IP/SEC and TCP/UDP port forwarding, with a full VPN client coming soon.
- The Digi Connect WAN can be configured using Access Control Lists for IP filtering to allow only certain incoming traffic. NAT support is also provided to hide private Ethernet connected IP addresses.
- Secure management of the Digi Connect WAN/RG can be provided via passwords, by blocking certain services such as telnet, and the ability to use HTTPS and SSH to manage the device. Optionally, the data traffic to a Digi Connectware Manager can be secured using SSL. The Digi Connect WAN/RG supports up to 256 bit AES encryption.



## 4.2 Coverage

The major CDMA and GSM carriers have excellent coverage in urban areas and varying coverage in rural areas. Coverage maps can be obtained from the carriers' web sites, or by contacting the carrier for more specific coverage information. Specific location coverage can vary due to many factors, including both natural and man-made obstacles. A site survey should be performed prior to deployment which will also aid in selection of an appropriate antenna solution and location. For additional information on carriers and wireless service coverage, refer to the carrier information in the next chapter.

## 4.3 Antenna Selection

The best data throughput may be achieved from placing the device antenna in an area with the greatest Received Signal Strength Indicator (RSSI). RSSI is a measurement of the Radio Frequency (RF) signal strength between the base station and the device, expressed in dBm which is the measured power level in decibels relative to 1 milliwatt. The better the signal strength, the less data retransmission and, therefore, better overall data throughput. The following table shows the RSSI coverage ranges:

RSSI	Coverage
-101 dBm or less	Unacceptable
-100 dBm to -91 dBm	Weak
-90 dBm to -81 dBm	Moderate
-80 dBm or greater	Good

Improvements in RSSI can be obtained in a number of ways, including antenna location, improved antenna gain, or using more aggressive antenna repeaters.

Antennas should be placed clear of obstructions and for optimal reception on the roof of a building. Extending the antenna coax cable should be avoided as this introduces additional signal loss. If additional distance is required, it is best to place the device near the antenna and extend the Ethernet cable. Alternatively, a Low Noise Amplifier (LNA – sometimes called a Booster) can be deployed to overcome antenna coax extension. Care must be taken to ensure a low-loss coax cable is selected for any extension.

Most commercial antenna suppliers specify gain in dBi (gain over an isotropic radiator), a theoretical antenna that radiates equally well in all directions. If an antenna is specified in dBi gain, it will appear to have approximately 2.15 dB higher gain than one specified in dBd (gain over a half-wave dipole). Higher gain omni-directional antennas typically have a gain of 3dBi. Directional antennas are also available for line-of-sight



direction to the nearest cell tower. Directional antennas include Grid, Yagi, and Panel antennas with gains varying from 6 dBi to 18 dBi.

A repeater is a device that helps to boost the wireless signal strength within a building and can be very useful when many devices are located in a common area. A repeater uses an external antenna in combination with an amplifier. The amplified signal is then fed to an internal distribution antenna system within the common area.

Additional considerations for antenna selection/deployment:

- Ensure that the antenna bandwidth covers the cellular/PCS frequency used. Some antennas are single band while others are multi-band.
- Some antennas require a ground plane while others have a built-in ground plane. A ground plane can be achieved by placing the antenna on an 18" metal plate or object.
- Keep the coax cable away from interference such as AC wiring.

Check with your Digi Sales Representative for additional information on Digi-supplied antenna options and third-party compatible antenna solutions, or visit the Digi Connect WAN/RG product website at <http://www.digi.com/products/wireless/> and follow the link to the wireless/cellular product page.



## 5 Complete Wireless Solution

Establishing a connection to a wireless device and accessing those devices on a network require three important pieces.

- **Hardware:** A wireless product such as the Digi Connect WAN or Digi Connect RG.
- **Activation:** Provisioning of the wireless product onto the wireless network.
- **Management:** The ability to update, monitor and reconfigure the wireless product from a central site.

### 5.1 Hardware and Distribution

Some hardware distributors sell devices but do not offer activation services while others bundle activation with the hardware purchase. Buying a pre-activated wireless product requires the customer to contact a wireless carrier to identify a proper rate plan, IP connection type, and ensure adequate wireless coverage within the area of deployment.

Solution providers that provide both hardware and wireless service activation can help simplify this process for customers. Digi International strives to establish business relationships with partners that can provide value to end users.

An updated listing of distributors and partners is available on the Digi website at <http://www.digi.com/applications/remotedevicemanagement/solutionpartners.jsp>.

### 5.2 Wireless Carriers

Wireless carriers can be divided into one of two categories, GSM or CDMA. While both GSM and CDMA coverage are available in the United States, this is not true in the rest of the world.

CDMA (Code Division Multiple Access) is a wireless technology delivered in the United States by carriers such as Sprint PCS and Verizon. While coverage in the US is good, it is very spotty in International markets. Coverage maps for CDMA carriers are available at <http://www.cdg.org>.

GSM (Global System for Mobile Communications) is the dominant global standard for wireless communications. On a global level, GSM represents over 80% of digital subscribers. Wireless carriers such as T-Mobile and Cingular deliver GSM in North America. Listings of international carriers can be obtained on the GSM World web site at <http://www.gsmworld.com>.

Digi International continues to certify products with wireless carriers around the world. An updated listing of these certifications along with contact information for each carrier is available on the Digi website at <http://www.digi.com/products/wireless> by following the links to the wireless/cellular product page.



### 5.3 Managing Remote Devices

Before deploying wireless devices in the field, consideration must be taken on how those devices will be maintained and monitored. Sending technicians on site to check status, upgrade firmware or modify a device's configuration can be both expensive and time consuming.

While modifying a device configuration, upgrading firmware, or monitoring a devices status can be accomplished over the wireless network, it typically requires a mobile terminated connection. In addition, when maintaining hundreds or thousands of remote wireless devices, having to touch each one individually takes time and can be very tedious.

The Digi Connectware Manager is an enterprise class server-based software toolset that eliminates these problems and provides the following features:

- View all devices securely from anywhere using standard web browser
  - Remote devices maintain persistent connection to Connectware Manager, even in mobile terminated applications
  - Batch configuration changes or firmware upgrades to one device or a thousand
- Notification via email and reports of problem devices

For more information about Digi Connectware Manager (including a live demo) visit <http://www.digi.com/products/wireless>.

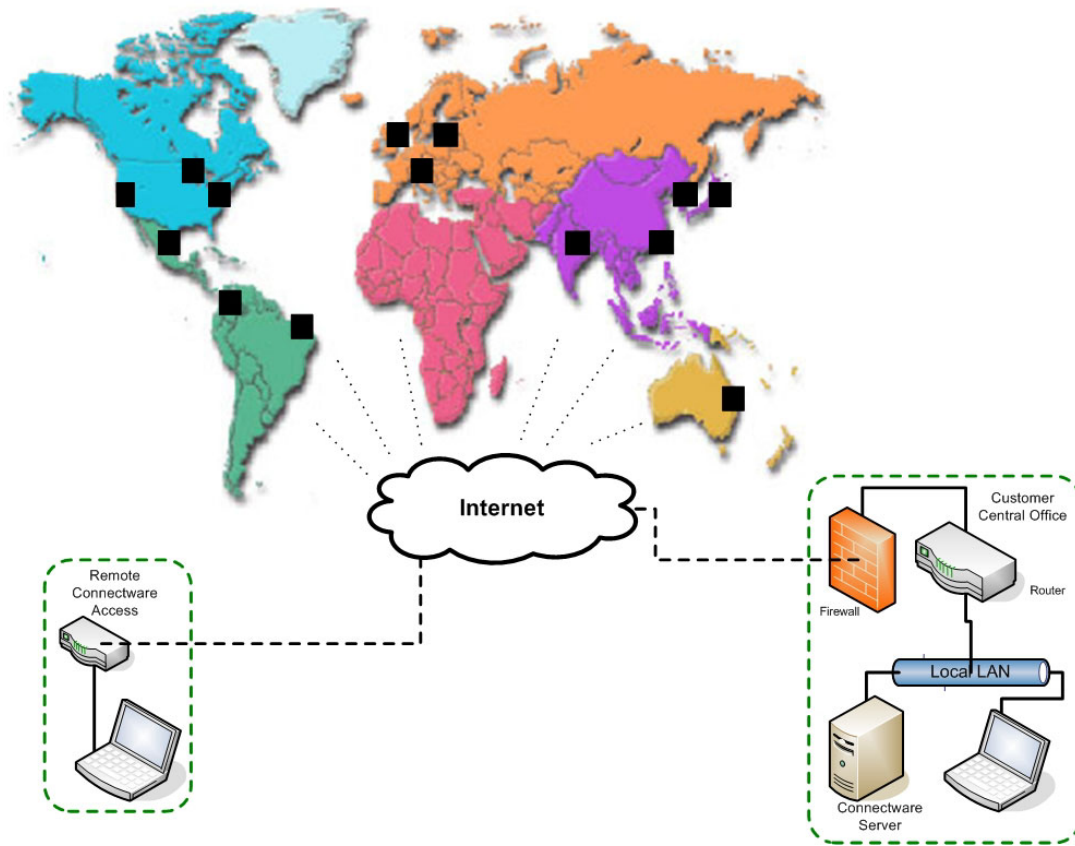

This graphic represents multiple remote devices installed around the world providing access to remote devices and networks back to a home office or company headquarters.

**Digi Connectware Manager Feature / Benefit**

Feature	Benefit
Remote Device Access	Secure access to devices from anywhere using standard web browser.
Remote Device Configuration	Configuration of remote device from anywhere, which reduces site visits.
Automatic Firmware Management/Upgrading	Devices can be upgraded automatically over the air which reduces site visits and truck rolls.
Alarm Generation and Alerting	Learn about problems without having to watch each device which reduces operational costs.
Automatic Provisioning	When a new device logs onto the network, it automatically phones home and downloads its specific configuration.



## 6 Glossary of Terms

**APN** – Access Point Name

**Cell** - The geographical area served by a cellular tower.

**CDMA (Code Division Multiple Access)** - A digital wireless technology that utilizes spread-spectrum techniques. Unlike competing systems that use TDMA, such as GSM, CDMA does not assign a specific frequency to each user. Instead, every channel uses the full available spectrum. Individual conversations are encoded with a pseudo-random digital sequence.

**CDMA2000 1xRTT** - 2.5G CDMA, doubles the voice capacity of CDMA networks and delivers peak packet data speeds of 307 Kbps in mobile environments.

**CO (Central Office)** - The central office is the lowest, or most basic level of switching in the PSTN network.

**CSD (Circuit-Switched Data)** - Circuit-switched data provides a temporary connection of two or more communications channels using a fixed, non-shareable path through the network.

**DNS** – Domain Name System

**Dynamic IP Address** – A type of IP address that is temporary and can change as frequently as every few hours.

**EDGE** – Enhanced Data Rates for GSM Evolution

**EVDO (Evolution Data Only)** – A high-speed 3G wireless technology for CDMA networks.

**FTP (File Transfer Protocol)** - A protocol used to transfer files over a TCP/IP network (like the Internet).

**GPRS (General Packet Radio System)** - A standard for cellular data communications which runs at speeds up to 85 Kbps. GPRS, which supports a wide range of bandwidths, is an efficient use of limited bandwidth and is particularly suited for sending and receiving small bursts of data, such as email and web browsing, as well as large volumes of data.

**GRE (Generic Router Encapsulation)** - A tunneling protocol for routers originally developed by Cisco.



**GSM (Global System for Mobile communications)** - One of the leading digital cellular systems. GSM uses narrowband TDMA, which allows eight simultaneous calls on the same radio frequency. GSM was first introduced in 1991. As of the end of 1997, GSM service was available in more than 100 countries and has become the de facto standard in Europe and Asia.

**IPSEC (Internet Protocol Security Protocol)** - Provides guaranteed per-packet authenticity and confidentiality between peers.

**Mobile Terminated** – A wireless connection type that is initiated by a host application.

**Mobile Originated** – A wireless connection type that is initiated by the remote device.

**NAT (Network Address Translation)** – An internet standard that enables a local-area network (LAN) to use one set of IP addresses for internal traffic and a second set of addresses for external traffic.

**Packet-Switched Network** - A method of transferring information in which data is broken into small pieces, called packets, and transported over shared communications channels.

**PCS (Personal Communication Services)** - A general term used to describe digital mobile telephony services including SMS text messaging or caller ID.

**Provisioning** - The process required to activate service on a particular wireless device, making that service available to the customer.

**PSTN** - The Public Switched Telephone Network that traditionally routes analog voice/data calls from one location to another over copper wires.

**PTCRB (PCS Type Certification Review Board)** – A certification process for GSM Mobile Equipment.

**OTA (Over-the-Air)** - IP-based activation technology, used by CDMA networks, that utilizes the wireless network to automatically identify the device, collect user data and complete provisioning.

**Private IP Address** – A type of IP address that is not routed over the public internet. Access to a private IP is done only by other devices that are also on the private network.

**Public IP Address** – A type of IP address that is routed over the public internet. Access to a public IP can be made by any device on a private or public network.

**SIM (Subscriber Identity Module)** - A smart card, used by GSM/GPRS devices, that securely stores the key identifying a mobile subscriber.





**SMS (Short Message Service)** - Similar to paging, SMS is a service for sending short text messages (up to 160 characters in length) to mobile phones/devices.

**Static IP Address** – A type of IP address that does not change over time.

**TCP/IP** – A group of protocols that define how computers transmit and route data packets over the internet.

**Telnet** - The TCP/IP standard network virtual terminal protocol that is used for remote terminal connection service and that allows a user at one site to interact with systems at other sites as if that user terminal were directly connected to computers at those sites.

**UMTS (Universal Mobile Telecommunications System)** – A high-speed 3G wireless data technology for GSM networks.

**VPN (Virtual Private Network)** - A private communications network that utilizes dedicated equipment and data encryption to securely connect remote sites or users together over the public Internet.